

12-2

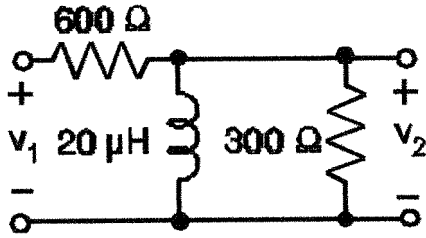

By voltage division we can compute the transfer function

$$T_v(j\omega) = \frac{j\omega L \parallel 300}{600 + j\omega L \parallel 300} = \frac{j\omega L(300)}{j\omega L(900) + 180,000}$$

Substituting in the value of L and doing some simplification gives

$$T_v(j\omega) = \frac{1}{3} \frac{j\omega(20 \times 10^{-6})}{j\omega(20 \times 10^{-6}) + 200} = \frac{1}{3} \frac{j\omega 10^{-7}}{j\omega 10^{-7} + 1} = \frac{1}{3} \frac{j\omega 10^{-7}}{1 + j\omega 10^{-7}} \quad (1)$$

(a)

At the low frequency limit $T_v(0) = 0$;

At the high frequency limit $T_v(\infty) = \frac{1}{3}$.

This is a high-pass filter with a single cutoff frequency determined by the denominator.

From the denominator $\omega_c = 10^7$.

(b) This expression for the transfer function is also often called the gain $T_v(j\omega) = G(\omega)$ which we denote by the symbol G. Since we already know the expression for the gain we can evaluate it for several frequencies giving:

$$G(0.5\omega_c) = 0.167$$

$$G(\omega_c) = 0.333$$

$$G(2\omega_c) = 0.333$$

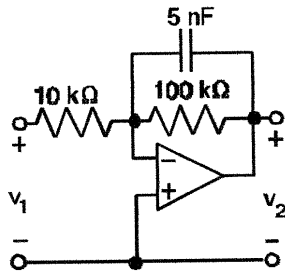

We can evaluate the transfer function using the formula for the gain of an OP AMP amplifier and recognizing that the 5nF capacitor and the 100kΩ resistor are in parallel.

$$T_v(j\omega) = -\frac{Z_2}{Z_1} = -\frac{\frac{1}{j\omega C} \parallel 10^5}{10^4} = -\frac{\frac{1}{j\omega C} \cdot 10^5}{\frac{1}{j\omega C} + 10^5} = -\frac{10^5}{10^4} \frac{\frac{1}{j\omega C}}{\frac{1}{j\omega C} + 10^5} = -10 \frac{1}{1 + j\omega C 10^5}$$

Substituting in the value of C gives

$$T_v(j\omega) = -10 \frac{1}{1 + j\omega(5 \times 10^{-9})10^5} = -10 \frac{1}{1 + j\omega(5 \times 10^{-4})}$$

(a) Evaluating this expression at $\omega = 0$ gives $T_v(0) = -10$;

This can also be evaluated as $\omega \rightarrow \infty$ to give $T_v(j\infty) = 0$.

This is a low-pass filter with a single cutoff frequency determined by the denominator. From the denominator we get $\omega_c = 2000$.

(b) The transfer function is also often called the gain $G(\omega) = T_v(j\omega)$ since this is really the frequency dependent gain of the OP AMP amplifier.

Plotting $G(\omega)$ using the straight line approximations discussed in class gives

$$20 \log_{10} |G(\omega)| = 20 \log_{10} |T_v(j\omega)| = 20 \log_{10} |-10| - 20 \log_{10} |1 + j\omega(5 \times 10^{-4})|$$

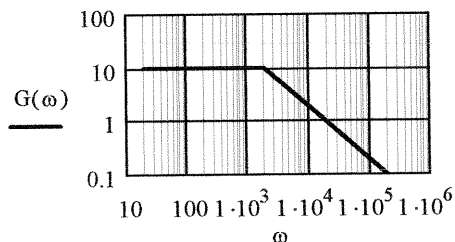

(c) The output voltage for a particular input voltage and frequency is simply the phasor magnitude of the input voltage times the gain expression evaluated for the frequency of the input, i.e., $V_o(\omega) = G(\omega) \times 5$

Computing the output voltage for several 5-volt peak sinusoids of different frequencies gives (Remember you know that $\omega_c = 2000$):

$$V_o(0.5\omega_c) = 50$$

$$V_o(\omega_c) = 50$$

$$V_o(2\omega_c) = 25$$

12-5

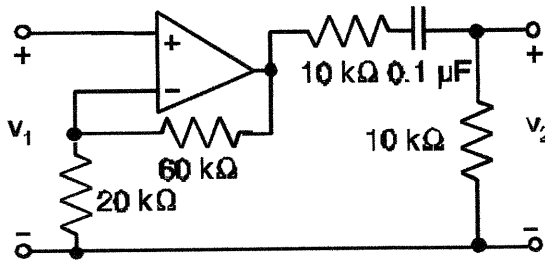

This is an interesting problem because it consists of an amplifier and a separate filter. The OP AMP amplifier produces a voltage at its output node which is then modified by the output voltage divider. This can be written as the product of the amplifier gain times the output voltage divider as shown below:

$$T_V(j\omega) = \left(\frac{60 + 20}{20} \right) \left[\frac{10^4}{10^4 + 10^4 + \frac{1}{j\omega 10^{-7}}} \right]$$

This can be simplified algebraically to give $T_V(j\omega) = 0.004 \frac{j\omega}{1 + j\frac{\omega}{500}}$

(a) Evaluating this expression for $\omega = 0$ gives $|T_V(0)| = 0$;

This can also be evaluated as $\omega \rightarrow \infty$ to give $|T_V(j\infty)| = 2$.

(b) This is a high-pass filter with a single cutoff frequency determined by the denominator.

By inspection of the denominator $\omega_c = 500$.

(c) The gain $G(\omega) = T_V(j\omega)$ and is plotted below using the straight line approximations discussed in class.

$$20 \log_{10} |G(\omega)| = 20 \log_{10} |T_V(j\omega)| = 20 \log_{10} \left| j \frac{\omega}{250} \right| - 20 \log_{10} \left| 1 + j \frac{\omega}{500} \right|$$

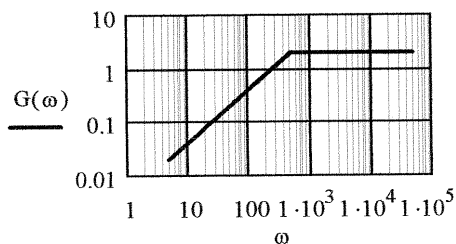

12-6

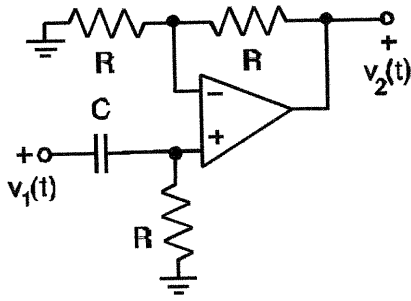

You can recognize this as a subtractor circuit by comparing it with Figure 4-40 of Thomas and Rosa, However, it is probably easiest to analyze by simply computing the voltages at the two inputs assuming an ideal OP AMP and then setting the inputs equal. Both input voltages are given by voltage divider relationships as

$$V_N(j\omega) = \frac{R}{R+R} V_2(j\omega)$$

$$V_P(j\omega) = \frac{R}{R + \frac{1}{j\omega C}} V_1(j\omega)$$

Setting these equal and then doing some re-arrangement gives

$$\frac{R}{R+R} V_2(j\omega) = \frac{R}{R + \frac{1}{j\omega C}} V_1(j\omega)$$

$$T_V(j\omega) = \frac{V_2(j\omega)}{V_1(j\omega)} = \left(\frac{R}{R + \frac{1}{j\omega C}} \right) \left(\frac{R+R}{R} \right) = \frac{j\omega 2RC}{1 + j\omega RC}$$

This is a high-pass filter with a single cutoff frequency coming from the denominator.

This expression can be evaluated as $\omega \rightarrow \infty$ to give the pass band gain $|T_V(\infty)| = 2$

To determine the component values for a linear cutoff frequency $f_c = 500$ Hz we

evaluate the expression for the angular cutoff frequency $\omega_c = \frac{1}{RC} = 2\pi(500)$. We

arbitrarily pick $R = 10^4$ which then requires $C = \frac{1}{R1000\pi} = 3.183 \times 10^{-8}$

12-9

You do not need to compute a transfer function for this circuit but simply need to plot its frequency dependence and understand its behavior. The transfer function is given to you

$$\text{as } T(j\omega) = \frac{0.1}{0.01 + \frac{20}{j\omega}}$$

Putting this into the standard form used in class gives

$$T_V(j\omega) = \frac{10j\omega}{j\omega + 2000} = \frac{j\omega(0.005)}{1 + j\omega(0.0005)}$$

(a) This is a high-pass filter with a single cutoff frequency determined by the denominator.

For frequencies above the cutoff frequency this circuit exhibits a gain K given by

$$K = \lim_{\omega \rightarrow \infty} T_V(j\omega) = \lim_{\omega \rightarrow \infty} \frac{j\omega(0.005)}{1 + j\omega(0.0005)} = \frac{j\omega(0.005)}{j\omega(0.0005)} = 10$$

By inspection of the denominator the cutoff frequency is given as $\omega_c = 2000$ radians/sec.

(b) The gain is simply the transfer function $\text{Gain}(\omega) = T_V(\omega)$

We use the straight line approximations discussed in class to plot this expression for $\text{Gain}(\omega)$:

$$20 \log_{10} |G(\omega)| = 20 \log_{10} |T_V(j\omega)| = 20 \log_{10} \left| j \frac{\omega}{200} \right| - 20 \log_{10} \left| 1 + j \frac{\omega}{2000} \right|$$

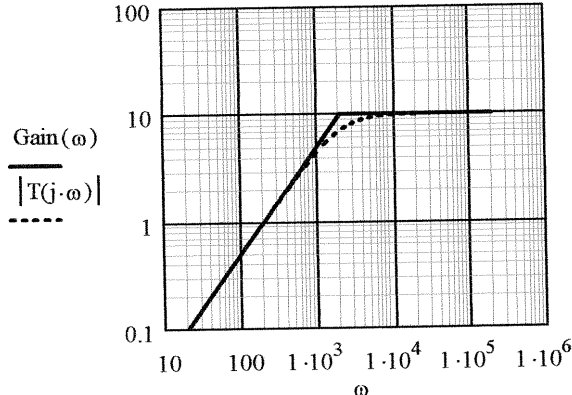

(c) Evaluating the gain expression at several frequencies gives

$$\text{Gain}(1000) = 5$$

$$\text{Gain}(2000) = 10$$

$$\text{Gain}(4000) = 10$$

This shows that the straight line approximation is pretty accurate.