

\*\*\*\* 03/07/93 15:56:52 \*\*\*\* Evaluation PSpice (Jan 1993) \*\*\*\*

CLASSROOM DEMO RLC CIRCUIT

\*\*\*\* CIRCUIT DESCRIPTION

\*\*\*\*\*

```
Vs 1 0 PWL 0,0 1u,10
L1 1 2 1m
R1 2 3 0.2
C1 3 0 1000u

E1 4 0 LAPLACE {v(1)} = {((1000*s)/(s*s+200*s+1E6))}
R4 4 0 1

E30 5 0 value = {10.06*exp(-100*time)*sin(995*time)}
R30 5 0 1
```

.TRAN 30m 30m

.PROBE  
.END

\*\*\*\* 03/07/93 15:56:52 \*\*\*\* Evaluation PSpice (Jan 1993) \*\*\*\*

CLASSROOM DEMO RLC CIRCUIT

\*\*\*\* INITIAL TRANSIENT SOLUTION TEMPERATURE = 27.000 DEG C

\*\*\*\*\*

NODE VOLTAGE NODE VOLTAGE NODE VOLTAGE NODE VOLTAGE

( 1) 0.0000 ( 2) 0.0000 ( 3) 0.0000 ( 4) 0.0000  
( 5) 0.0000

VOLTAGE SOURCE CURRENTS  
NAME CURRENT

Vs 0.000E+00

TOTAL POWER DISSIPATION 0.00E+00 WATTS

JOB CONCLUDED

TOTAL JOB TIME 31.63

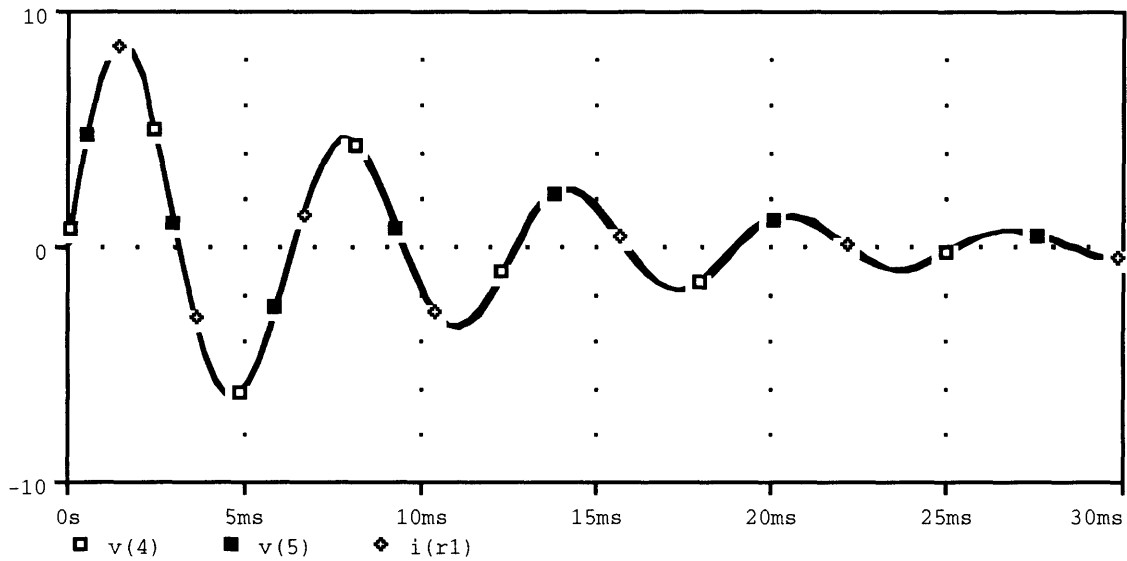

"CLASSROOM DEMO RLC CIRCUIT"

03/07/93 15:56:52

27.0°

Evaluation Probe 5.3 © 1993 MicroSim Corp.

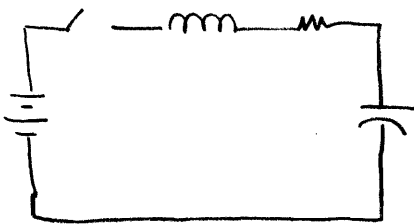

$$v(t) = L \frac{di}{dt} + Ri + \frac{1}{C} \int i dt$$

$$\frac{10}{s} = sLI(s) + RI(s) + \frac{I(s)}{sC}$$

$$I(s) = \frac{\frac{10}{s} - V(s)}{Ls + R + \frac{1}{sC}}$$

use transfer function

$$I(s) = V(s) \frac{1}{Ls + R + \frac{1}{sC}}$$



$$\frac{sC}{s^2LC + sRC + 1}$$

$$\frac{\frac{sC}{L}}{s^2 + s \frac{R}{L} + \frac{1}{LC}} = \frac{s/L}{s^2 + s \frac{R}{L} + \frac{1}{LC}}$$

## plotting transfer functions

voltage source  
Ename +node -node LAPLACE {expression} = {transform\_expression}.

current source  
Gname.

result is to create a voltage at node which is expression multiplied by transform expression

typical use:

Vin 2 0 ac 1

Rin 2 0 1

E1 1 0 LAPLACE {V(2)} = {10\*s / ((10+s)(1E4+s))}.

RE1 1 0 1

• AC DEC 40 .01 100K.

• PROBE

• END.

\*\*\*\* 03/03/93 13:11:37 \*\*\*\*\* Evaluation PSpice (Jan 1992) \*\*\*\*\*

Wheatstone bridge problem

\*\*\*\* CIRCUIT DESCRIPTION

\*\*\*\*\*

```
Vdc 1 0 15volts
R1 1 2 {Rratio}
R2 1 3 1000ohms
R3 2 0 500ohms
Rx 3 0 {R} ;variable resistor Rx
.param R=4.5
.param Rratio=1000
.dc lin param R 4 6 0.2 param Rratio LIST 100000
.probe
.end
```

JOB CONCLUDED

TOTAL JOB TIME .95

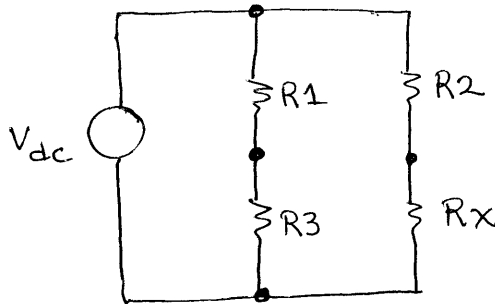

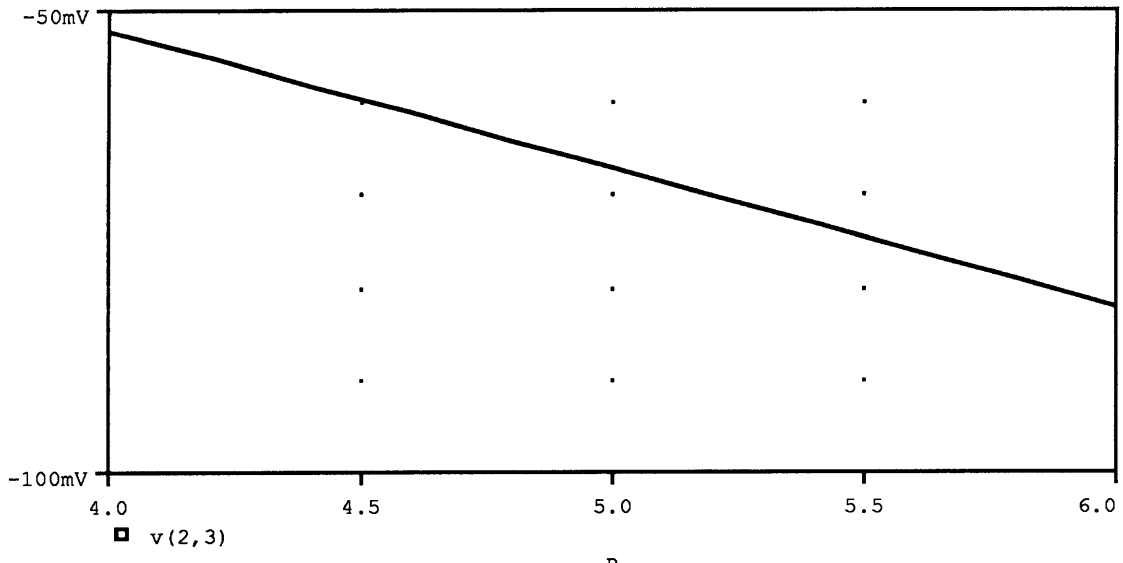

"Wheatstone bridge problem" 03/03/93 11:46:06 27.0°  
 Evaluation Probe 5.1 © 1992 MicroSim Corp.

$$R_{ratio} = 1,000,000 \Omega$$

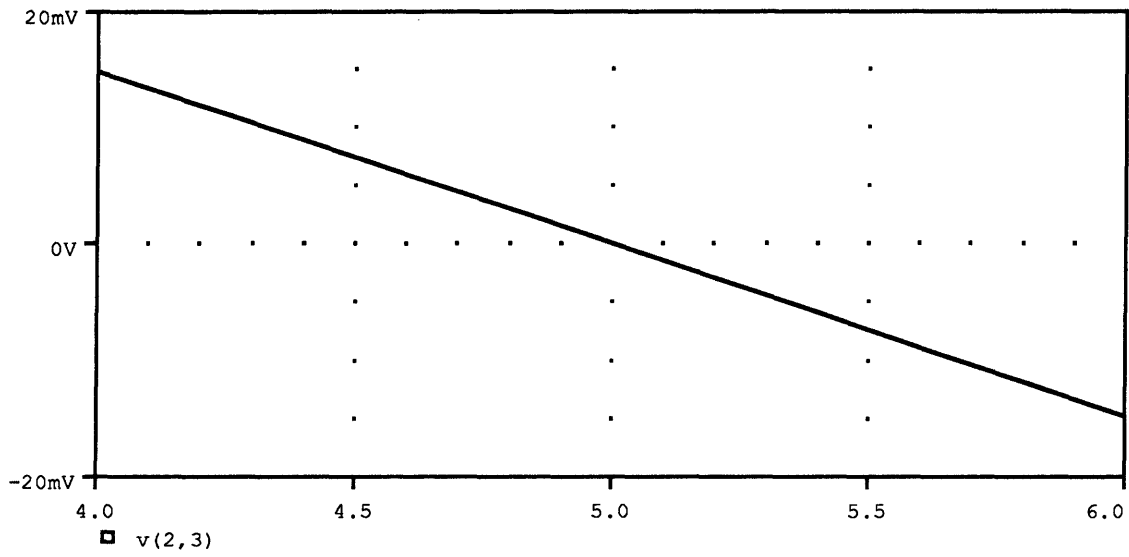

"Wheatstone bridge problem"      R      03/03/93 11:59:46      27.0°  
 Evaluation Probe 5.1 © 1992 MicroSim Corp.

$$R_{ratio} = 100,000$$

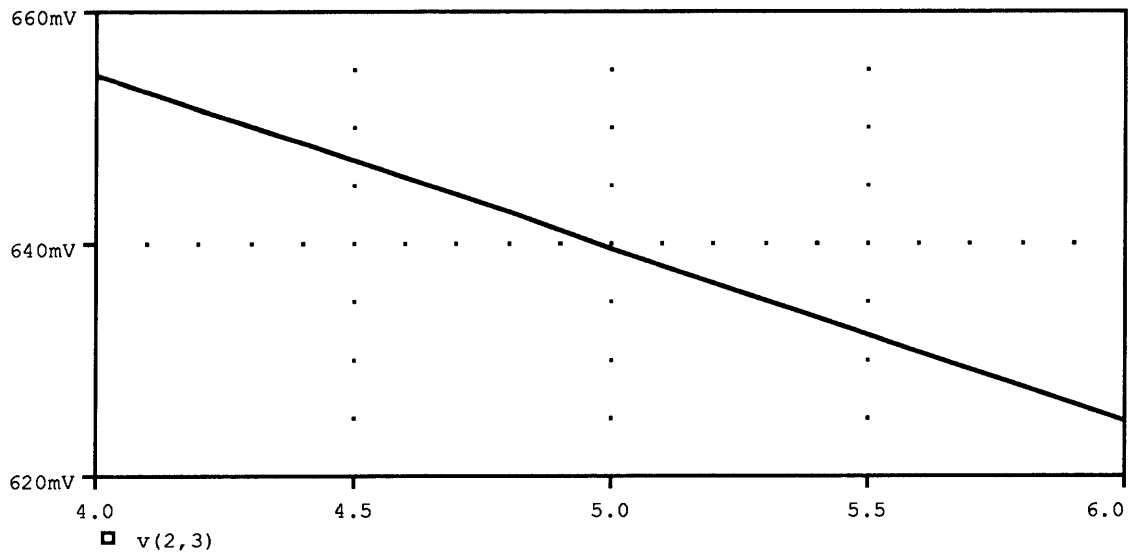

"Wheatstone bridge problem"      R      03/03/93 12:03:48      27.0°  
 Evaluation Probe 5.1 © 1992 MicroSim Corp.

$$R = 10,000$$

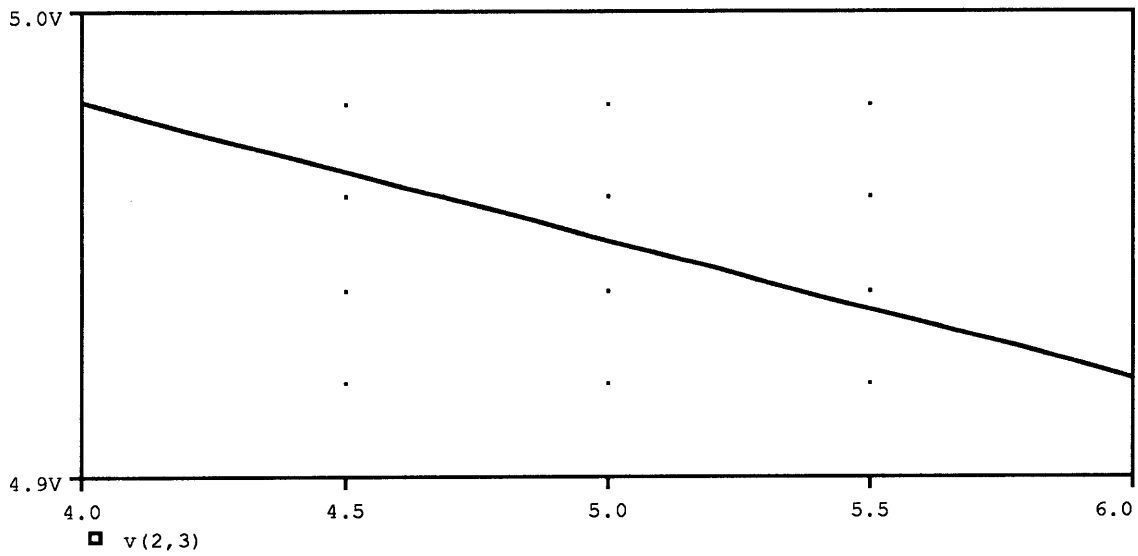

"Wheatstone bridge problem"      R      03/03/93 12:05:48      27.0°  
Evaluation Probe 5.1 © 1992 MicroSim Corp.

$$R = 1,000$$



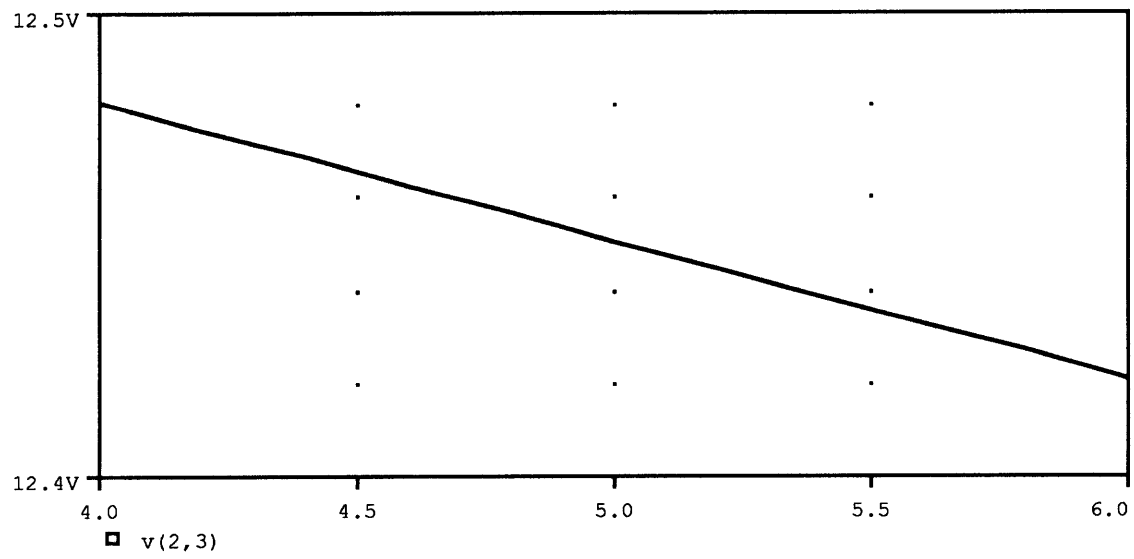

"Wheatstone bridge problem"      R      03/03/93 12:07:50      27.0°  
 Evaluation Probe 5.1 © 1992 MicroSim Corp.

$$R = 100 \Omega.$$

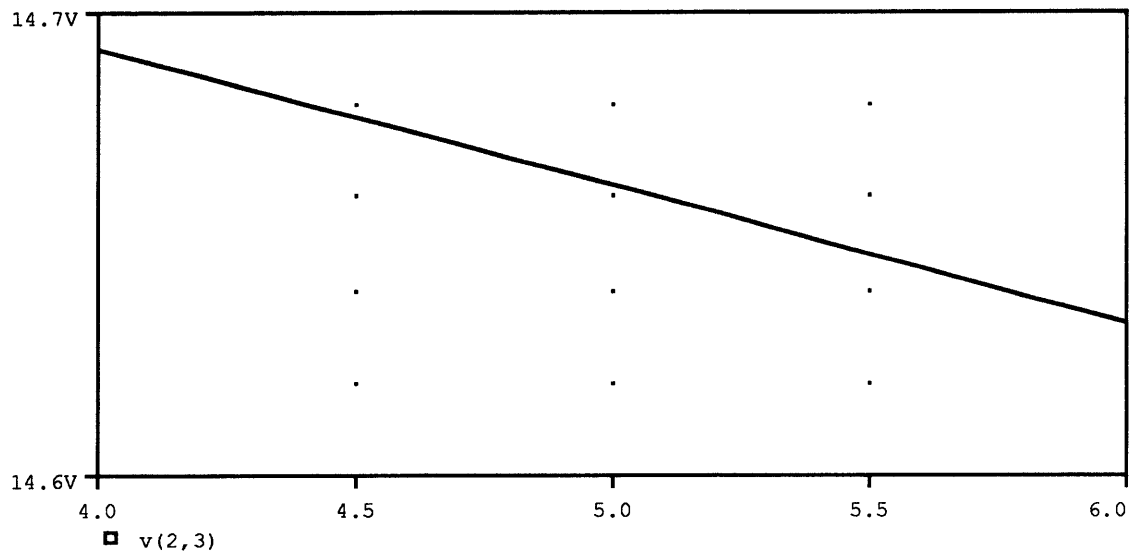

"Wheatstone bridge problem" 03/03/93 13:08:06 27.0°  
Evaluation Probe 5.1 © 1992 MicroSim Corp.

$$R = 10$$

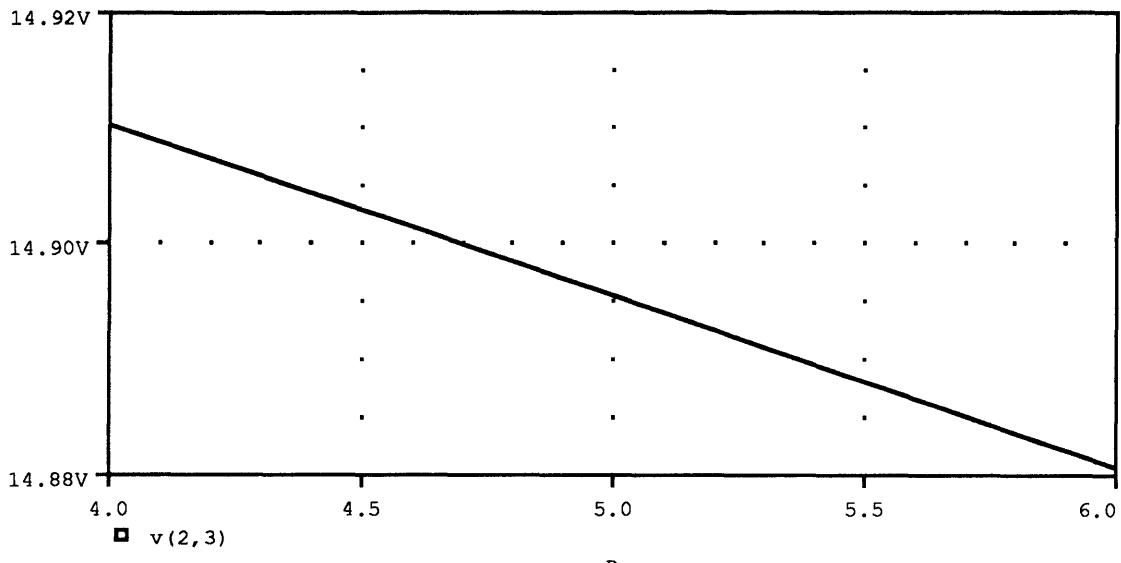

"Wheatstone bridge problem" 03/03/93 13:09:45 27.0°  
 Evaluation Probe 5.1 © 1992 MicroSim Corp.

$$R = 1$$

\*\*\*\* 03/03/93 13:40:28 \*\*\*\*\* Evaluation PSpice (Jan 1992) \*\*\*\*\*

Problem 4.79 Nillson

\*\*\*\* CIRCUIT DESCRIPTION

```
*****
Vdc  1  0  40volts
Vsens 2  5  ;sense voltage for controlled current source
Vload 4  6  ;sense voltage for power calculations
; since no value is given for sense voltages they default to zero
F1  3  4  Vsens 30
;the direction is reversed because of the passive sign convention thru Vsens
R1  1  2  2k
R2  2  3  5k
R3  3  4  10k
R4  5  0  20k
R5  3  0  50k
R6  4  0  40k
Ro  6  0  {R} ;variable load resistor
.param R=5k
.dc dec param R 100 100k 10
.probe
.end
```

JOB CONCLUDED

TOTAL JOB TIME 1.78

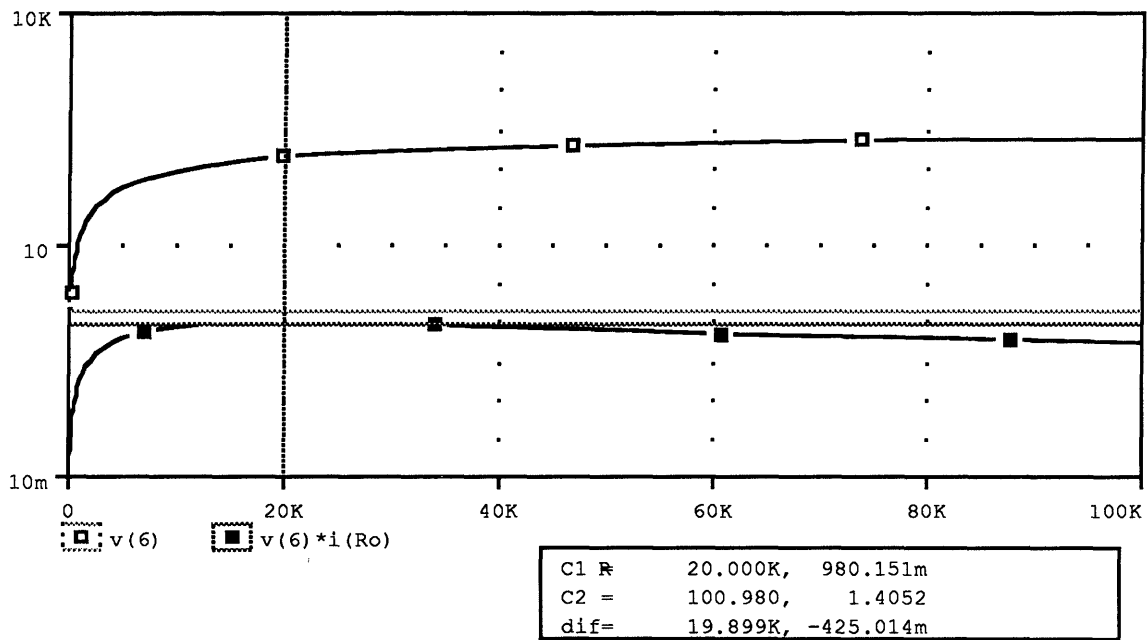

max 979.999 mW  
@ 19.953k

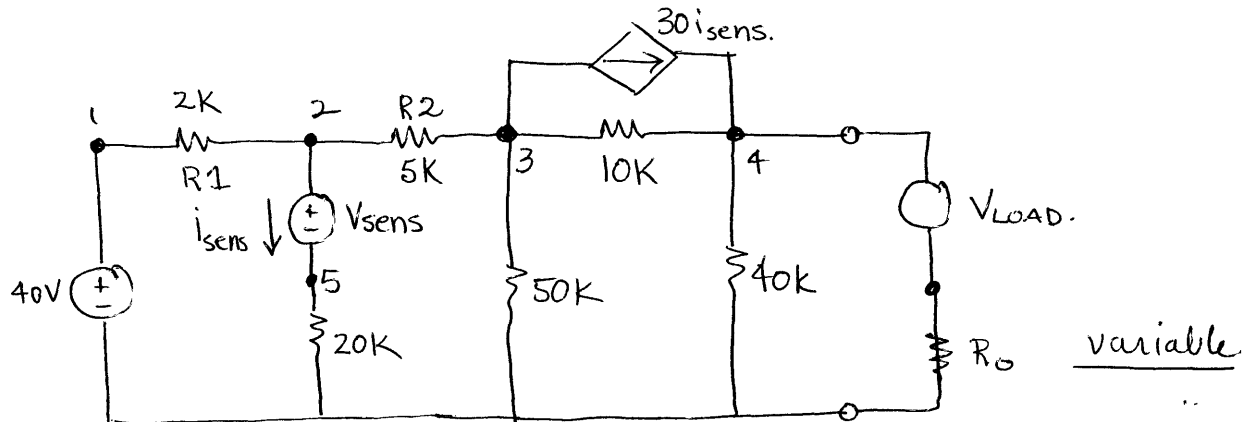

EEAP 244 Homework

100

Name : Gabriel NG  
Typed

Gabriel NG  
Signature

By signing this page I am indicating that this lab and the work described in this report is my own.

Title : Homework #1(Pspice program and analysis for problem 3-53 and 4-79)

Problem 4-79

Problem Statement : Find  $R_o$  in the circuit given in problem 4-79 that will maximize the power through  $R_o$

Analysis : The above problem has been analyzed using pspice program by setting  $R_o$  to various values. Upon several trial and errors, maximum value of power through  $R_o$  occurs around 16000 to 24000 ohm. Further investigation is continued using a stepsize of 1000 ohm by running the pspice program again. The program text and the output file are shown below as necessary :

Schematic diagram of the circuit

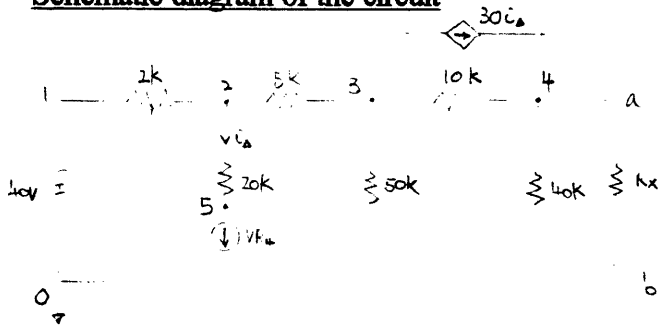

Program text

\* Circuit for problem 4.79 (homework #1)  
\* in this circuit, VR4 is used as a dummy voltage source

```
V0 1 0 dc 40
R1 1 2 2000
R2 2 3 5000
R3 3 4 10000
R4 2 5 20000
R5 3 0 50000
R6 4 0 40000
Rx 4 0 20000
VR4 5 0 dc 0
fl 3 4 VR4 30
.op
```

.probe  
.end

Output file at (20000 ohm)

\*\*\*\*\* 03/04/93 \*\*\*\*\* Evaluation PSpice (July 1989) \*\*\*\*\* 18:55:56 \*\*\*\*\*

\* Circuit for problem 4.79 (homework #1)

\*\*\*\* CIRCUIT DESCRIPTION

\*\*\*\*\*

\* in this circuit, VR4 is used as a dummy voltage source

V0 1 0 dc 40  
R1 1 2 2000  
R2 2 3 5000  
R3 3 4 10000  
R4 2 5 20000  
R5 3 0 50000  
R6 4 0 40000  
Rx 4 0 20000  
VR4 5 0 dc 0  
f1 3 4 VR4 30  
.op  
.print dc V(3,4)  
.probe  
.end

\*\*\*\*\* 03/04/93 \*\*\*\*\* Evaluation PSpice (July 1989) \*\*\*\*\* 18:55:56 \*\*\*\*\*

\* Circuit for problem 4.79 (homework #1)

\*\*\*\* SMALL SIGNAL BIAS SOLUTION TEMPERATURE = 27.000 DEG C

\*\*\*\*\*

NODE VOLTAGE NODE VOLTAGE NODE VOLTAGE NODE VOLTAGE

( 1) 40.0000 ( 2) 18.4000 ( 3) -31.0000 ( 4) 140.0000

( 5) 0.0000

VOLTAGE SOURCE CURRENTS  
NAME CURRENT

V0 -1.080E-02  
VR4 9.200E-04

TOTAL POWER DISSIPATION 4.32E-01 WATTS

\*\*\*\*\* 03/04/93 \*\*\*\*\* Evaluation PSpice (July 1989) \*\*\*\*\* 18:55:56 \*\*\*\*\*

\* Circuit for problem 4.79 (homework #1)

\*\*\*\* OPERATING POINT INFORMATION    TEMPERATURE = 27.000 DEG C

\*\*\*\*\*

\*\*\*\* CURRENT-CONTROLLED CURRENT SOURCES

NAME        fi  
I-SOURCE    2.760E-02

JOB CONCLUDED

TOTAL JOB TIME        1.05



Graph : Shown in the following pages. Please consult those for references  
Answers to the problem

(a) From the graph shown, maximum power through  $R_o$  occurs when  $R_o$  is 20000 ohm. Therefore, the value of  $R_o$  should be 20000 ohm.

(b) From the graph shown, the corresponding power through  $R_o$  is 0.98 watt.

(c) percentage delivered to  $R_o$  is :  $0.98/4.32 * 100\% = 22.68\%$

### Problem 3-53

Problem statement : Find the setting of  $R_2/R_1$  so that the unknown resistor in the wheatstone bridge as shown can be measured up to four significant figures

Analysis : Problem mentioned above has been analyzed using pspice program as required. <sup>in two ways</sup>  
In the 1<sup>st</sup> case, The value of  $R_x$  is set between 4 to 5 ohm in each case. For each  $R_2/R_1$  ratio to be investigated, the value of  $R_3$  is changed until the wheatstone bridge is in its equilibrium state, which means the voltage across node 2 and 3 (or vice versa, depending on the sign) shown in the figure is zero. See graph 2 for 2<sup>nd</sup> method + explanation

#### Schematic diagram of the circuit

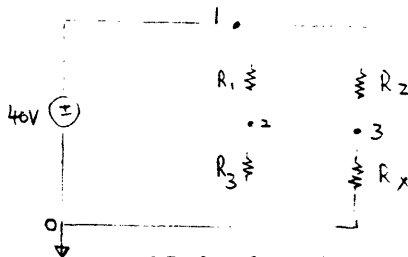

#### Program text (Notice the voltage between node 2 and 3 is zero)

\* Circuit for problem 3.53(homework #1)

```
V1 1 0 dc 40
R1 1 2 1
R2 1 3 1000
R3 2 0 0.0045
Rx 3 0 4.5
.print dc v(3,2)
.probe
.end
```

#### Corresponding output file for the program shown above

\*\*\*\*\* 03/05/93 \*\*\*\*\* Evaluation PSpice (July 1989) \*\*\*\*\* 01:10:49 \*\*\*\*\*

\* Circuit for problem 3.53(homework #1)

\*\*\*\* CIRCUIT DESCRIPTION

\*\*\*\*\*

```

V1 1 0 dc 40
R1 1 2 1
R2 1 3 1000
R3 2 0 0.0045
Rx 3 0 4.5
.print dc v(3,2)
.probe
.end

```

\*\*\*\*\* 03/05/93 \*\*\*\*\* Evaluation PSpice (July 1989) \*\*\*\*\* 01:10:49 \*\*\*\*\*

\* Circuit for problem 3.53(homework #1)

\*\*\*\* SMALL SIGNAL BIAS SOLUTION TEMPERATURE = 27.000 DEG C

\*\*\*\*\*

NODE VOLTAGE NODE VOLTAGE NODE VOLTAGE NODE VOLTAGE

( 1) 40.0000 ( 2) .1792 ( 3) .1792

VOLTAGE SOURCE CURRENTS

NAME CURRENT

V1 -3.986E+01

TOTAL POWER DISSIPATION 1.59E+03 WATTS

JOB CONCLUDED

TOTAL JOB TIME .65

Answer to the problem : From the graph plotted, we can see if the  $R_2/R_1$  ratio is 1000, 100, or 10, the resistance  $R_3$  needed is <sup>around</sup> 0.0045, 0.045 and 0.45 <sup>ohm</sup> respectively, which is not possible because the value of  $R_3$  has to lie between 1 to 11110 ohm. Furthermore, as the accuracy of  $R_3$  is less than 4, so for  $R_x$  to be measured up to four significant figures, the  $R_2/R_1$  should have 4 significant figures. Therefore, the ratio  $R_2/R_1$  should be 0.001 in order to satisfy the above two constraints.

$$R_x = \frac{R_2}{R_1} R_3$$

$R_3$  from graph I have at most 4 sig. figures

⇒  $R_2/R_1$  should have 4 sig. figures so

that  $R_x$  can be measured up to 4

sig. figures.

Graph for questions 4-79

Voltage	Ro	Power(w)
124.44	16000	0.967832
128.65	17000	0.973577
132.63	18000	0.97726
136.41	19000	0.97935
140.89	20000	0.98
143.41	21000	0.979353
146.67	22000	0.97782
149.77	23000	0.97526
152.73	24000	0.971936

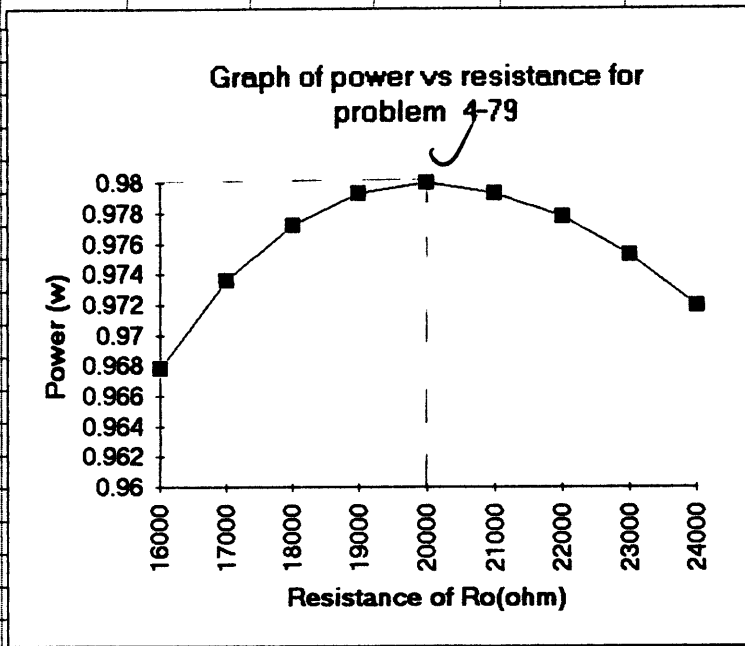

Graph for problem 3-53

v(3,2)	Rx	4	4.5	5
0.0045	1000	-0.0198	0	0.0198
0.045	100	-0.184	0	0.1823
0.45	10	-0.985	0	0.919
4.5	1	-0.727	0	0.606
4.6	0.1	-0.857	-0.13	0.476
440	0.01	-0.593	0.134	0.74
4800	0.001	-1.103	-0.376	0.23

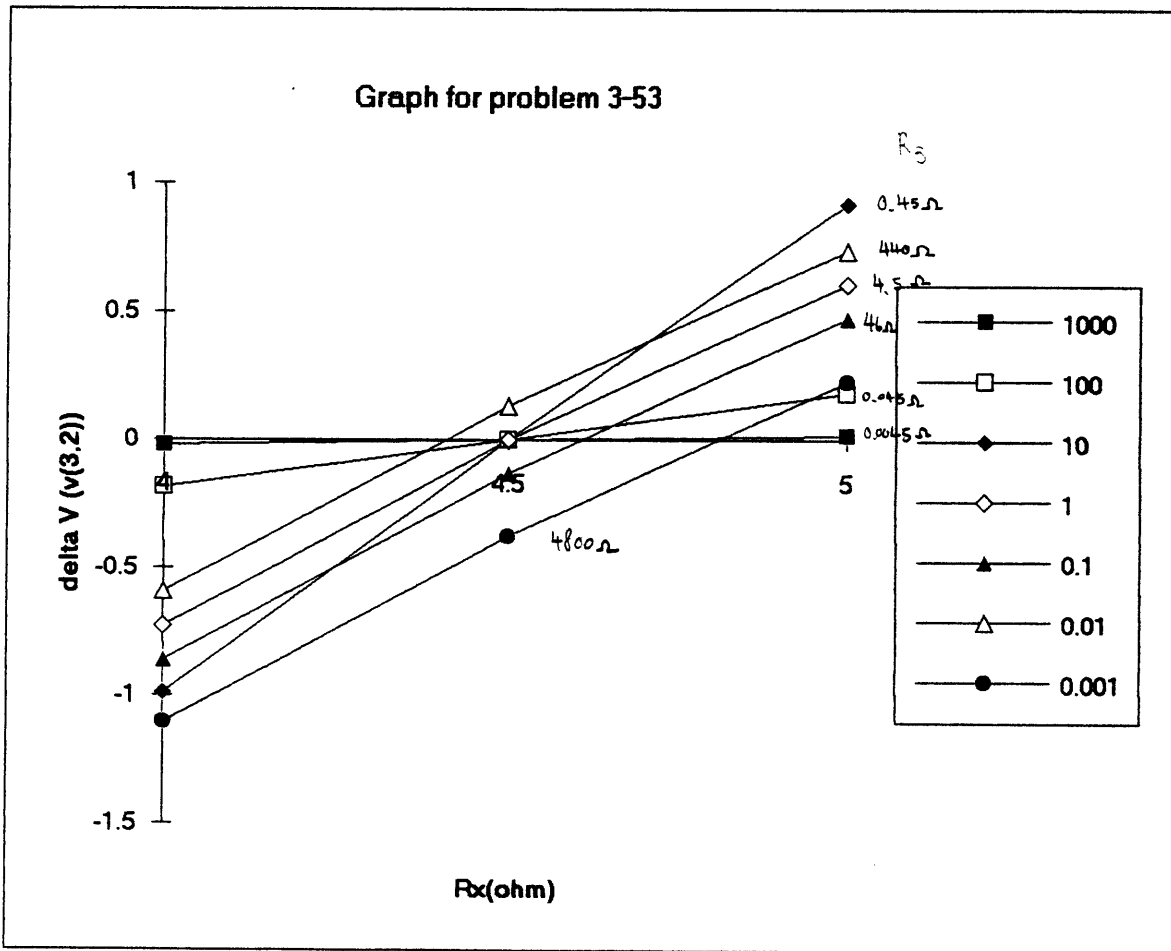

Remark:  $R_s$  is adjusted to different values for different ratios.

Graph for problem 3-53

delta V ratio	Rx(ohm)	4	4.5	5
1000		39.8316	39.8118	39.792
100		38.4525	38.2685	38.0862
10		28.562	27.577	26.658
1		7.991	7.264	6.658
0.1		0.967	0.861	0.775
0.01		0.091	0.0808	0.071
0.001		0.001	0	-0.001

Method 2 =

$$4 \leq R_3(0.001) \leq 5$$

$$\Rightarrow 4000 \leq R_3 \leq 5000$$

Choose  $R_3 = 4500 \Omega$

plot the graph

From the graph, equilibrium condition is attained when ratio is 0.001 only,  $\Rightarrow R_2/R_1$  should be 0.001

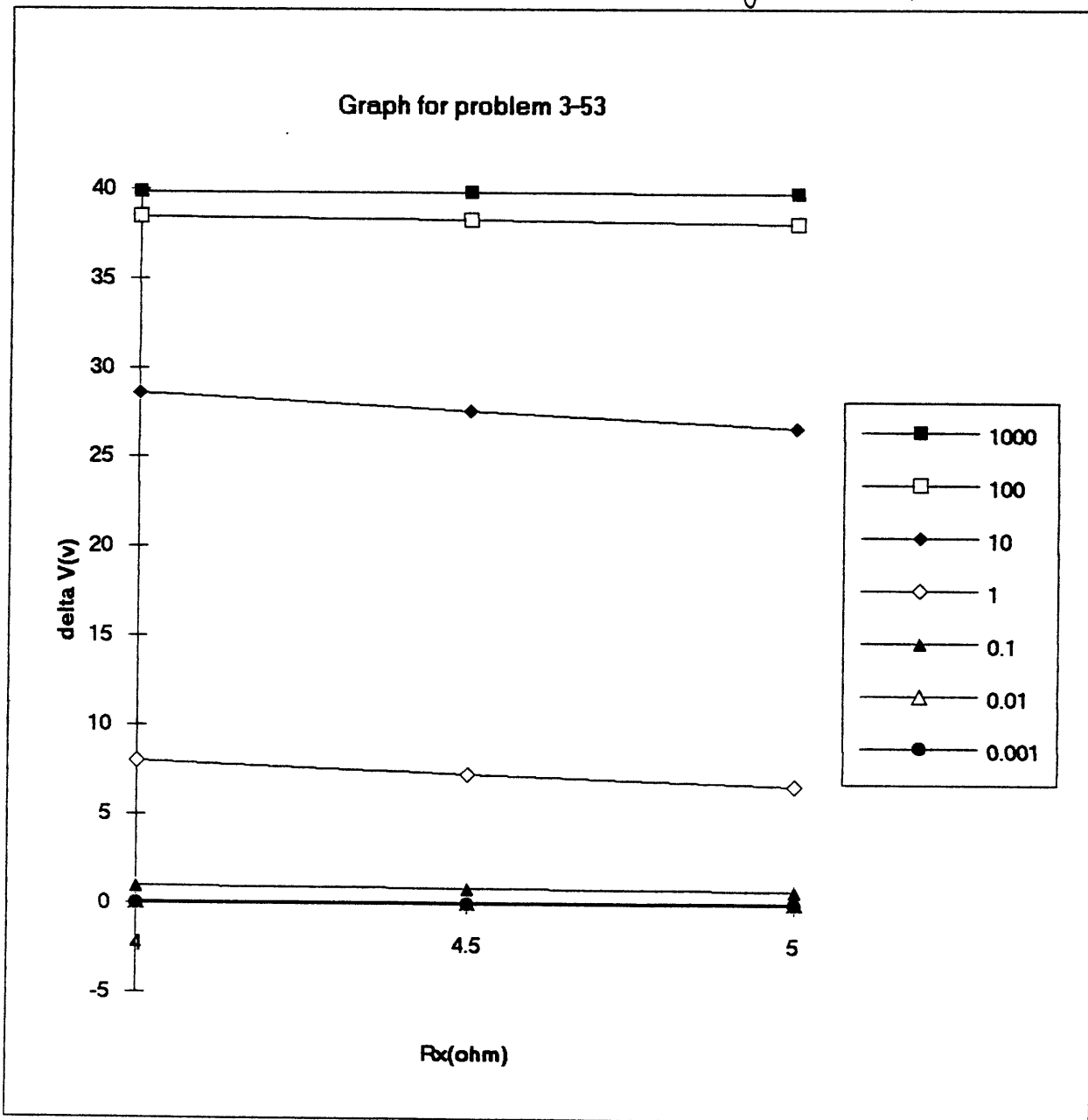

Peter Kreymerman  
EEAP 244  
Pspice (WheatStone Bridge)  
3.53

100

Nice  
Work

The enclosed data table and graph demonstrate the characteristics of a WheatStone Bridge simulated with Pspice. The WheatStone circuit is balanced when the voltage difference across the middle nodes is zero and therefore the equation  $R2/R1 = Rx/R3$  must hold true. The 8th program listing and following results demonstrate this perfectly.

The problem required us to determine the value of the ratio  $R2/R1$  (.001, .01, .1, 1, 10, 100, or 1000) so that  $Rx$  was between 4 and 5 ohms and was four significant digits.  $R3$  is a dial-a-ohm which ranges from 1 to 11,110 ohms in increments of 1. It was important to pick the proper  $R3$  to satisfy the stated conditions. I chose  $R3$  to be 4444 ohms, but anything between the 4000 to 5000 range (with 4 significant digits) is fine. By using this value for  $R3$  and .001 for the  $R2/R1$  ration I calculated  $Rx$  ( $Rx=4.444$  ohms) to four significant digits and within the specified range. If any other  $R2/R1$  ratio was used,  $Rx$  would have less than 4 significant digits.

In conclusion, the data table and graph demonstrate that the WheatStone Bridge is indeed balanced when  $R3=4444$  ohms,  $Rx=4.444$  ohms, and  $R2/R1=.001$ , because these values show that the change in voltage across the middle nodes is zero. ✓

50

	Rx (ohm)	Node 2 (V)	Node 3 (V)	Voltage Change
1	4.000	4.0816	4.0000	0.082
2	4.000	4.8900	4.0000	0.890
3	4.000	4.9888	4.0000	0.989
4	4.000	4.9989	4.0000	0.999
5	4.000	4.9989	1.4286	3.570
6	4.000	4.9989	0.1923	4.807
7	4.000	4.9989	0.0199	4.979
8	4.444	4.0816	4.0816	0.000
9	4.444	4.8900	4.0816	0.808
10	4.444	4.9888	4.0816	0.907
11	4.444	4.9989	4.0816	0.917
12	4.444	4.9989	1.5384	3.461
13	4.444	4.9989	0.2127	4.786
14	4.444	4.9989	0.0221	4.977
15	5.000	4.0816	4.1667	-0.085
16	5.000	4.8900	4.1667	0.723
17	5.000	4.9888	4.1667	0.822
18	5.000	4.9989	4.1667	0.832
19	5.000	4.9989	1.6667	3.332
20	5.000	4.9989	0.2381	4.761
21	5.000	4.9989	0.0249	4.974

### WheatStone Bridge (delta V vs. Rx)

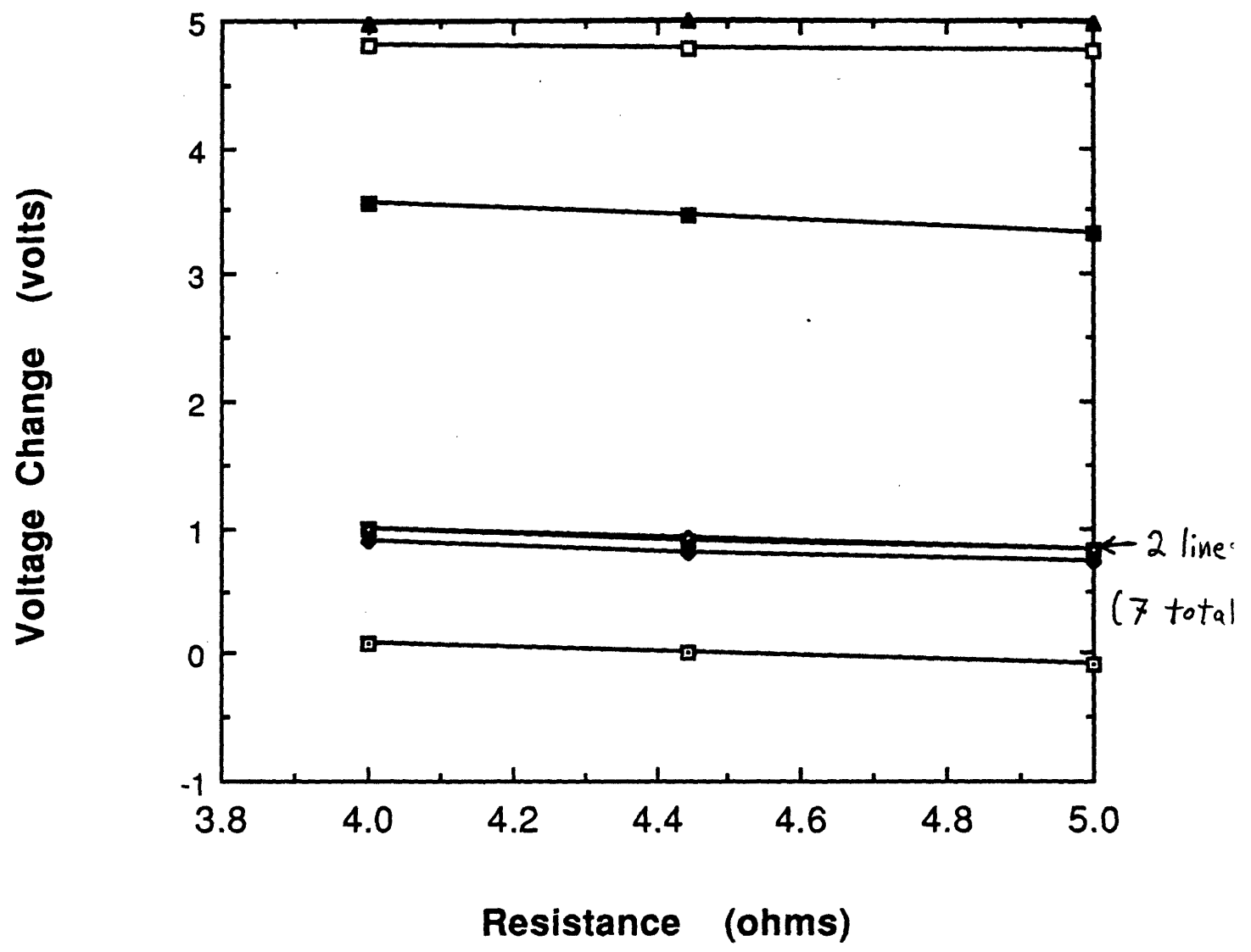



Peter Kreymerman  
EEAP 244  
Pspice (Power Transfer)  
4.79

- a) The maximum power transferred to the variable resistor ( $R_o$ ) came when  $R_o=20$  kohms. The data table and graphical representation proved that this value is true.  $R_o$  can also be determined by calculating the Thevenin Resistance of the Circuit. ✓
- b) The maximum power delivered to  $R_o$  was .980 watts and this value can be proven by examining the data table and graph. ✓
- c) The percentage of total power which is in  $R_o$  is about 19 percent. This value was determined by evaluating the sources (using KCL and KVL) and then finding the power delivered by each ( $P=VI$ ). The power delivered to  $R_o$  was divided by the total power (from the sources) and multiplied by 100, getting the percentage which we desired. ✓

	Resistance	Voltage (V)	Current (A)	Power (watts)
1	2.000	25.455	0.01273	0.324
2	4.000	46.667	0.01167	0.545
3	6.000	64.610	0.01077	0.696
4	8.000	80.000	0.01000	0.800
5	10.000	93.333	0.00933	0.871
6	12.000	105.000	0.00875	0.919
7	14.000	115.290	0.00823	0.949
8	16.000	124.440	0.00778	0.968
9	18.000	132.630	0.00737	0.977
10	20.000	140.000	0.00700	0.980
11	22.000	146.670	0.00667	0.978
12	24.000	152.730	0.00636	0.972
13	26.000	158.260	0.00609	0.963
14	28.000	163.330	0.00583	0.953
15	30.000	168.000	0.00560	0.941
16	32.000	172.310	0.00538	0.928
17	34.000	176.300	0.00519	0.914
18	36.000	180.000	0.00500	0.900
19	38.000	183.450	0.00483	0.886
20	40.000	186.670	0.00467	0.871
21	42.000	189.680	0.00452	0.857
22	44.000	192.500	0.00438	0.842
23	46.000	195.150	0.00424	0.828
24	48.000	197.650	0.00412	0.814
25	50.000	200.000	0.00400	0.800

### Resistance for Maximum Power

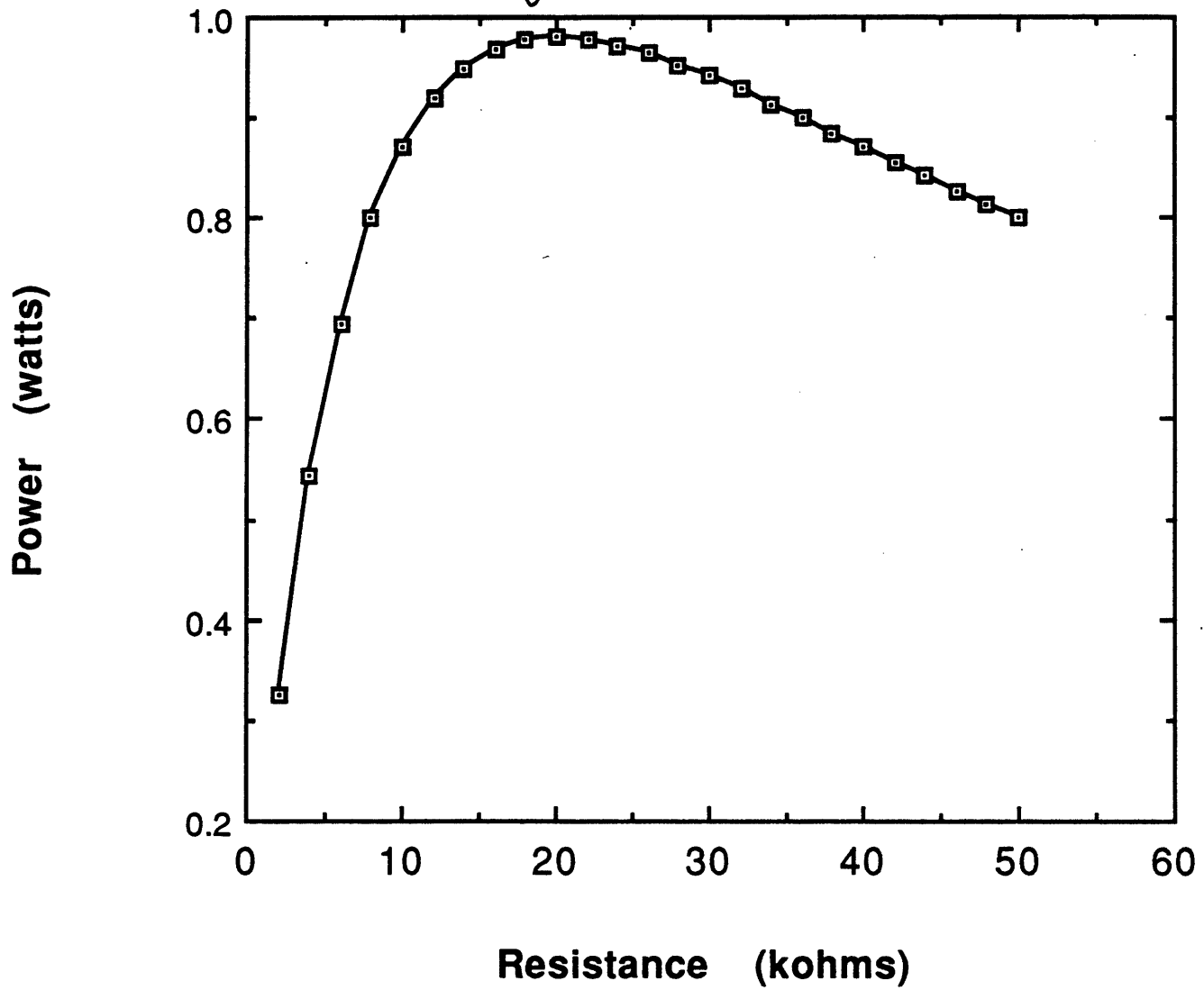

```

Power Transfer
`Sources
Vs 1 0 DC 40
F1 3 4 V2 30
*Dummy Sources
V2 2 5 DC 0
V3 4 6 DC 0
*Elements
R1 5 0 20000
R2 3 0 50000
R3 4 0 40000
R4 1 2 2000
R5 2 3 5000
R6 3 4 10000
R0 6 0 Rmod 1
.Model Rmod Res(R=1)
.Step Lin Res Rmod(R) 2000, 50000, 2000
*Output
.Print DC V(4), I(V3)
.END

```

```

**** CURRENT STEP RMOD R = 2.0000E+03
*****
*
( 1) 40.0000 ( 2) 13.8180 ( 3) -48.1820 ( 4) 25.4550

```

```

VOLTAGE SOURCE CURRENT
V3 1.273E-02

```

```

TOTAL POWER DISSIPATION 5.24E-01 WATTS

```

```

**** CURRENT STEP RMOD R = 4.0000E+03
*****
*
( 1) 40.0000 ( 2) 14.6670 ( 3) -45.0000 ( 4) 46.6670

```

**EEAP 244**  
**PSPICE - ASSIGNMENT**

**NAME: Anand C. Patel**

**Signature:** Anand C Patel

**SS # : 216-06-5433**

**ASSIGNMENT #1:** The objective of this assignment is to understand the construction and principle of the Wheatstone Bridge using the Circuit Simulation Software PSPice. The main objective of the assignment is to select a particular ratio  $R2/R1$  from the given seven ratios so that the unknown resistor  $R_x$  that has a value between  $4\Omega$  and  $5\Omega$  can be measured upto four significant digits.

**ASSIGNMENT #2:** The objective of this assignment is to understand the concept of power development and power consumption in a circuit. The main objective is to analyze how the change in value of a load resistor affects the amount of power that resistor draws from the source circuit.

98

## ASSIGNMENT #1

**AIM:** The objective of this assignment is to understand the construction and principle of the Wheatstone Bridge using the Circuit Simulation Software PSpice. The main objective of the assignment is to select a particular ratio  $R2/R1$  from the given seven ratios so that the unknown resistor  $R_x$  that has a value between  $4\Omega$  and  $5\Omega$  can be measured upto four significant digits. Then finally plot the graphs  $R_x$  .vs.  $\Delta V$  for each of the seven ratios.

**GIVEN DATA:**

- 1) The ratios  $R2/R1$  can have the values 0.001, 0.01, 0.1, 1, 10, 100, 1000.
- 2)  $R3$  can have a value between 1 to 11,110 $\Omega$  in increments of 1 $\Omega$ .
- 3)  $R_x$  has a value between 4 $\Omega$  and 5 $\Omega$ .

**CIRCUIT DIAGRAM:**

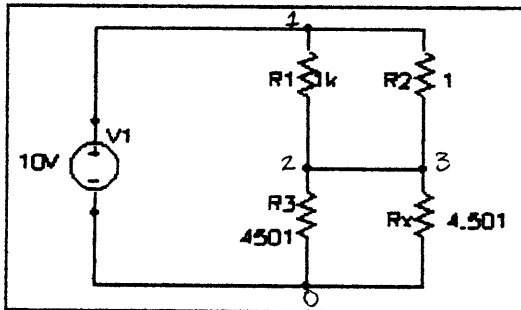

fig. The above circuit has element values for the ratio  $R2/R1=0.001$

**PRINCIPLE OF THE WHEATSTONE BRIDGE:**

The principle of the Wheatstone Bridge is that the ratio  $(R2 / R1) = (Rx / R3)$  is true only when the voltage at nodes 2 and 3 is the same, ie, the bridge is balanced. Thus in such a case if  $R1$ ,  $R2$  and  $R3$  are known the value of the unknown resistor  $R_x$  can be found easily using the ratio.

**OBSERVATIONS:**

$R1$  remains constant for all ratios = 1000 $\Omega$

$R3$  remains constant for all ratios = 4501 $\Omega$

V(2) Volts	V(3) Volts	$\Delta V$ (Volts)	$R_x$ ( $\Omega$ )
$R2 / R1 = 0.001$			
$R2 = 1\Omega$			
8.1821	8.0048	0.1773	4.012
8.1821	8.1821	0 ✓	4.501
8.1821	8.3547	0.1726	5.078

V(2) Volts	V(3) Volts	$\Delta V$ (Volts)	R <sub>x</sub> ( $\Omega$ )
R <sub>2</sub> / R <sub>1</sub> = 0.01			
R <sub>2</sub> = 10 $\Omega$			
8.1821	2.8633	5.3188	4.012
8.1821	3.1039	5.0782	4.501
8.1821	3.3678	4.8143	5.078

V(2) Volts	V(3) Volts	$\Delta V$ (Volts)	R <sub>x</sub> ( $\Omega$ )
R <sub>2</sub> / R <sub>1</sub> = 0.1			
R <sub>2</sub> = 100 $\Omega$			
8.1821	0.3857	7.7964	4.012
8.1821	0.4307	7.7514	4.501
8.1821	0.4833	7.6988	5.078

V(2) Volts	V(3) Volts	$\Delta V$ (Volts)	R <sub>x</sub> ( $\Omega$ )
R <sub>2</sub> / R <sub>1</sub> = 1.0			
R <sub>2</sub> = 1000 $\Omega$			
8.1821	0.04	8.1421	4.012
8.1821	0.0448	8.1373	4.501
8.1821	0.0505	8.1316	5.078

V(2) Volts	V(3) Volts	$\Delta V$ (Volts)	R <sub>x</sub> ( $\Omega$ )
R <sub>2</sub> / R <sub>1</sub> = 10.0			
R <sub>2</sub> = 10000 $\Omega$			
8.1821	0.004	8.1781	4.012
8.1821	0.0045	8.1776	4.501
8.1821	0.0051	8.177	5.078

V(2) Volts	V(3) Volts	$\Delta V$ (Volts)	R <sub>x</sub> ( $\Omega$ )
R <sub>2</sub> / R <sub>1</sub> = 100.0			
R <sub>2</sub> = 100000 $\Omega$			
8.1821	0.0004012	8.1816988	4.012
8.1821	0.0004501	8.1816499	4.501
8.1821	0.0005078	8.1815922	5.078

V(2) Volts	V(3) Volts	$\Delta V$ (Volts)	$R_x$ ( $\Omega$ )
$R_2 / R_1 = 1000.0$			
$R_2 = 1000000\Omega$			
8.1821	0.00004012	8.18205988	4.012
8.1821	0.00004501	8.18205499	4.501
8.1821	0.00005078	8.18204922	5.078

**SOLUTION:**

From the above observations we see that  $R_x$  is measured to four significant digits when the ratio  $R_2 / R_1$  has the value 0.001. For this ratio  $R_x$  has the value  $4.501\Omega$  and therefore it also satisfies the principle of the wheatstone bridge, ie, the wheatstone bridge is balanced and  $\Delta V$  is zero.

Now, I chose  $R_3$  to be equal to  $4501\Omega$  for the following reason :-  
 To get the value of  $R_x$  to be upto 4 significant digits and also to be between  $4\Omega$  and  $5\Omega$ ,  $R_3$  can have any value between  $4001\Omega$ ,  $4101\Omega$ , .....,  $4551\Omega$ , .....,  $4667\Omega$ , .....,  $4999\Omega$ .  
 Another reason for this limit over  $R_3$  is that it's value can not exceed  $11,110\Omega$  and has to be a whole number since it can be varied in increments of  $1\Omega$  only.



PSpice Problem 3.53-FOR THE RATIO R2/R1=0.001

Vs	1 0	DC	10
R1	1 2	1000	
R2	1 3	1	
R3	2 0	4501	
RX	3 0	4.012	

.END

PSpice Problem 3.53-FOR THE RATIO R2/R1=0.001

Vs	1 0	DC	10
R1	1 2	1000	
R2	1 3	1	
R3	2 0	4501	
RX	3 0	4.501	

.END

PSpice Problem 3.53-FOR THE RATIO R2/R1=0.001

Vs	1 0	DC	10
R1	1 2	1000	
R2	1 3	1	
R3	2 0	4501	
RX	3 0	5.078	

.END

## ASSIGNMENT #2

**AIM:** The objective of this assignment is to understand the concept of power development and power consumption in a circuit. The main objective is to analyze how the change in value of a load resistor affects the amount of power that resistor draws from the source circuit. Then plot a graph of  $R_o$  vs.  $Power[R_o]$ .

### CIRCUIT DIAGRAM:

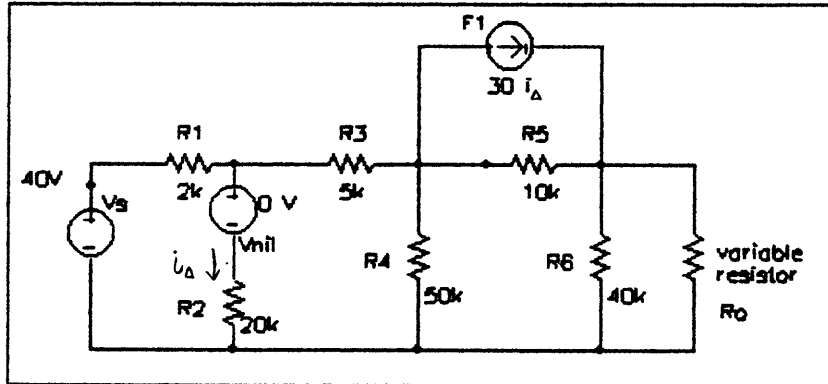

fig. In the above circuit  $R_o$  is the load connected to the rest of the circuit.

### THEORY:

The following formula for Power is used in the calculations

$$\text{Power} = V \cdot I = \frac{V \cdot V}{R} = I \cdot I \cdot R$$

In the circuit on calculation it is found that the voltage source  $V_s$  and current source  $F1$  produce power while all the resistors consume power. The resistance  $R_o$  acts like a load to the entire circuit. It is also true that the resistance  $R_o$  consumes the maximum power from the circuit, when  $R_o$  is equal to the Thevenin Equivalent of the circuit. Therefore if we know the current flowing through  $R_o$  or the voltage across its terminals we can calculate the power it will consume from the circuit using one of the above formulas.

**OBSERVATIONS:**

<b>Ro (<math>\Omega</math>)</b>	<b>I(Ro) amp.</b>	<b>Power(Ro) watts</b>	<b>% consumed</b>
10000	0.00933	0.870489	8.090
10500	0.00918	0.8848602	8.224
11000	0.009032	0.897347264	8.340
11500	0.008889	0.908664692	8.445
12000	0.00875	0.91875	8.539
12500	0.008615	0.927727813	8.622
13000	0.008485	0.935937925	8.698
13500	0.008358	0.943058214	8.764
14000	0.008235	0.94941315	8.824
14500	0.008116	0.955107112	8.876
15000	0.008	0.96	8.922
15500	0.007887	0.96417392	8.961
16000	0.007778	0.967956544	8.996
16500	0.007671	0.970929977	9.024
17000	0.007568	0.973668608	9.049
17500	0.007467	0.975731558	9.068
18000	0.007368	0.977173632	9.082
18500	0.007273	0.978585787	9.095
19000	0.007179	0.979222779	9.101
19500	0.007089	0.97995146	9.107
20000	0.007	0.98	9.108
20500	0.006914	0.979969618	9.108
21000	0.006829	0.979340061	9.102
21500	0.006747	0.978723194	9.096
22000	0.006667	0.977875558	9.088
22500	0.006588	0.97653924	9.076
23000	0.006512	0.975341312	9.065
23500	0.006437	0.973721772	9.049
24000	0.006364	0.972011904	9.034
24500	0.006292	0.969936968	9.014
25000	0.006222	0.9678321	8.995

( \*\*\*\* continued \*\*\*\* )

25500	0.006154	0.965728758	8.975
26000	0.006087	0.963340794	8.953
26500	0.006022	0.961008826	8.931
27000	0.005957	0.958117923	8.904
27500	0.005895	0.955653188	8.882
28000	0.005833	0.952668892	8.854
28500	0.005773	0.949834577	8.827
29000	0.005714	0.946844084	8.800
29500	0.005657	0.944048646	8.774
30000	0.0056	0.9408	8.743

### CALCULATIONS:

$$\begin{aligned} \text{Total power developed in the circuit} &= P(V_s) + P(F1) \\ &= 0.008 * 40 + 30 * 0.0012 * (280+10) \\ &= 10.76 \text{ Watts} \end{aligned}$$

### Sample Calculation:

Consider  $R_o = 20K\Omega$  ✓

Power delivered to  $R_o = 0.98 \text{ Watts}$  ✓

The percentage of the total power developed in the circuit

$$\begin{aligned} \text{that is delivered to } R_o &= (0.98 * 100) / 10.76 \\ &= 9.108 \% \end{aligned}$$

TOTAL POWER X ?

### RESULTS:

A). The value of  $R_o$  for which maximum power is transferred to it = **20KΩ**

This value of  $R_o$  is also the Thevenin Equivalent of the circuit.

B). The maximum power delivered to  $R_o$  by the circuit = **0.98 Watts**

C). The percentage of the total power developed in the circuit  
that is delivered to  $R_o = 9.108 \%$

On plotting  $R_o$  vs.  $Power[R_o]$  we see from the curve that, the power being transferred from the circuit to  $R_o$  increases until  $R_o$  reaches the Thevenin Equivalent of the circuit. There after the power being transferred to  $R_o$  from the circuit begins to drop.

Problem No. 4.79; PSpice Homework-1, POWER RELATED

Vs 1 0 DC 40

Vnil 2 3 DC 0

R1 1 2 2K

R2 3 0 20K

R3 2 4 5K

R4 4 0 50K

R5 4 5 10K

R6 5 0 40K

Ro 5 0 RMOD 1

F1 4 5 Vnil 30

.MODEL RMOD RES(R=1)

.STEP LIN RES RMOD(R) 10000,30000,500

.DC Vs 0 40 40

.PRINT DC I(Ro), V(5)

.PROBE

.END

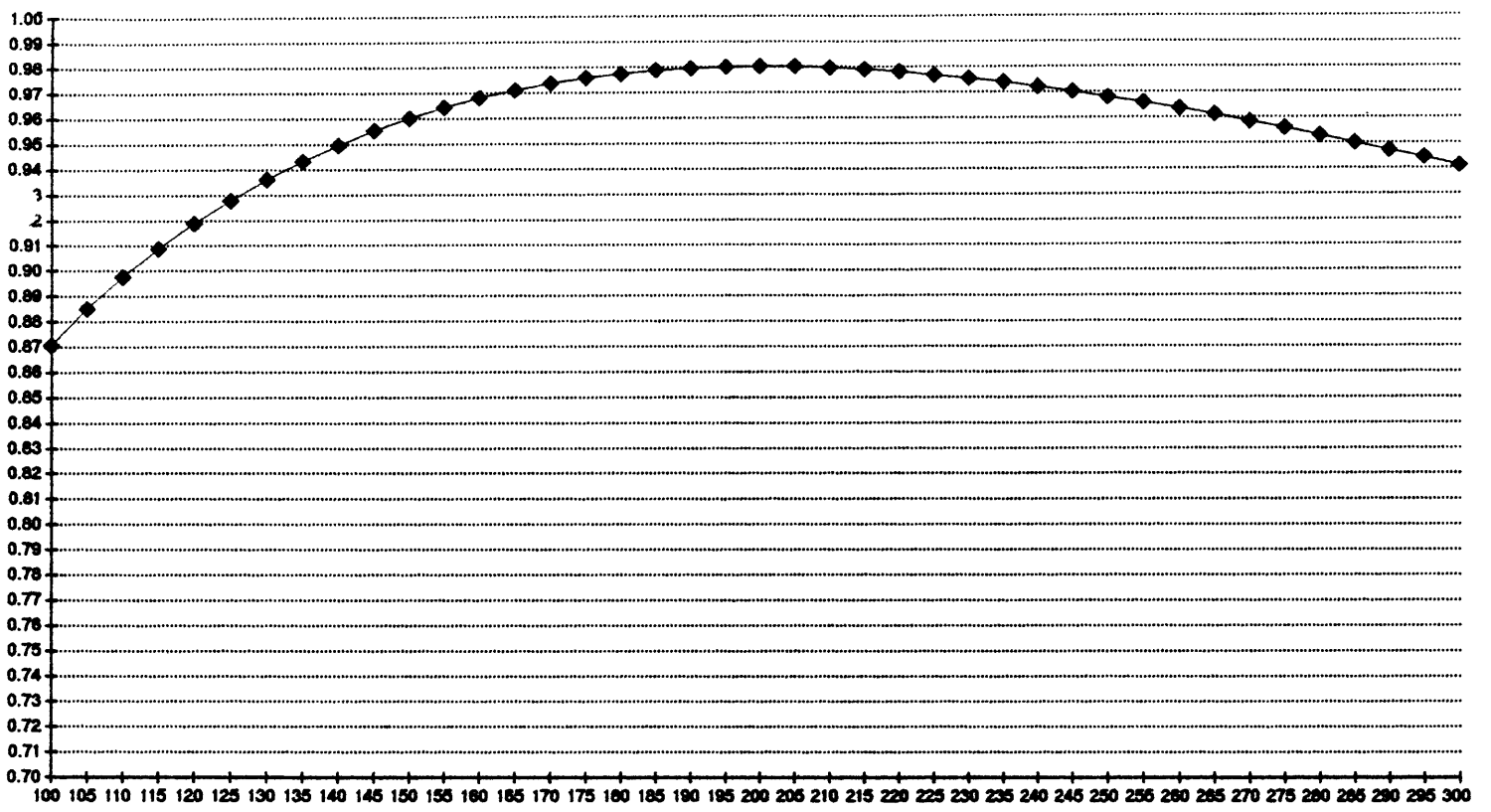

100

EEAP 244

# **P-SPICE Homework #1**

3-53, 4-79

David Sarafian

3-5-93

## Problem 3-53

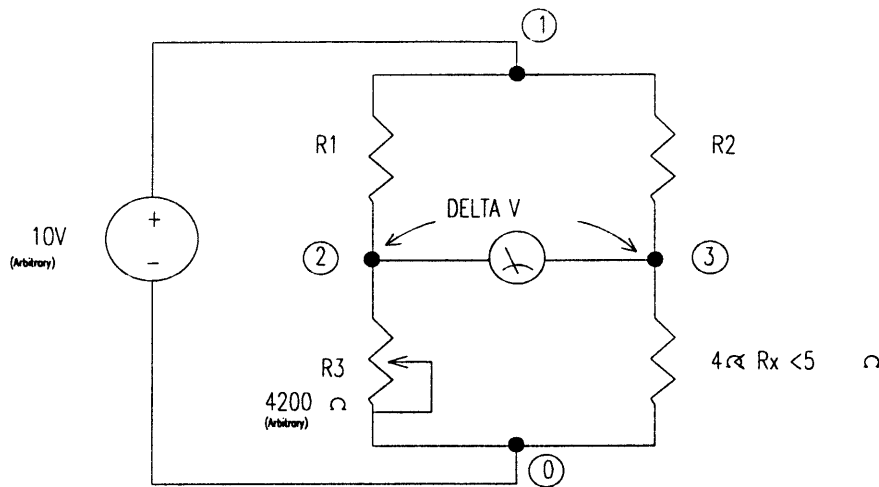

**Figure 1** Wheatstone bridge with P-SPICE nodes indicated

The task for this Wheatstone bridge problem is to select the proper ratio of  $R2/R1$ , so that the unknown ( $R_x$ ) can be measured to an accuracy of 4 decimal places with the digital variable resistor. The bridge (Fig. 1) is "balanced" when the voltage difference between nodes 2 and 3 (delta V) is zero. Since the bridge is actually two voltage dividers, the "balanced" condition is satisfied when:

$$R1/R2 = R_x/R3$$

The digital variable resistor ( $R3$ ) has a maximum value of 11,110 $\Omega$ . Changing the ratio  $R2/R1$  has a multiplying effect on  $R3$  (and also the range of measurable  $R_x$  for a given ratio). Since the desired accuracy is 4 significant figures, and the unknown is between 4 $\Omega$  and 5 $\Omega$ ,  $R3$  should have at least 1 integer and 3 fractional figures. This happens to be the maximum number of fractional figures, since the most significant digit of the resistor has a maximum value of 1 and cannot be set to 5.

When  $R2/R1 = 1$ ,  $R3$  is multiplied by 1, and indicates  $R_x$  directly in ohms (1 $\Omega$  steps). As the ratio is decreased, the (imaginary) decimal point on  $R3$  is moved to the left. When the ratio is 0.001,  $R3$  will indicate a maximum value of 11.110 $\Omega$ , which satisfies the requirements. A graph on the next page shows how delta V varies with  $R_x$ , for an arbitrary value of  $R3$  (4200 $\Omega$ ). The bottom curve shows the smallest values of delta V as  $R_x$  varies, and even crosses the zero axis indicating the balanced condition. This curve corresponds to the  $R2/R1$  ratio of 0.001, which would be the correct ratio to use.

The following is a copy of the code used in the simulation. Runs were made for each of the given  $R2/R1$  ratios

Problem 3-53 -- Wheatstone bridge

```
V1 1 0 DC 10
R2 1 3 10
R1 1 2 10000
Rx 0 3 Rmod 1 ;Define Rx as a variable
R3 0 2 4300
.MODEL Rmod RES (R=1) ;Define the model as a resistor
.STEP LIN RES Rmod (R) 4 5 0.5 ;Vary Rx from 4 to 5 (step=1/2)
.END
```



Rx=4 Ohms			Rx=4.5 Ohms			Rx=5 Ohms		
V(2)	V(3)	Delta V	V(2)	V(3)	Delta V	V(2)	V(3)	Delta V
3.007	2.857	0.1499	3.007	3.103	-0.0964	3.007	3.333	-0.3263
8.1132	2.857	5.2561	8.113	3.103	5.0098	8.113	3.333	4.7799
9.7727	2.857	6.9156	9.773	3.103	6.6693	9.773	3.333	6.4394
9.9768	2.857	7.1197	9.977	3.103	6.8734	9.977	3.333	6.6435
9.9768	0.385	9.5922	9.977	0.431	9.5462	9.977	0.476	9.5006
9.9768	0.04	9.937	9.977	0.045	9.932	9.977	0.05	9.927
9.9768	0.004	9.9728	9.977	0.005	9.9723	9.977	0.005	9.9718

Ratios of R1:R2 Vs Unknown Rx With Arbitrary R3 (4.2K)

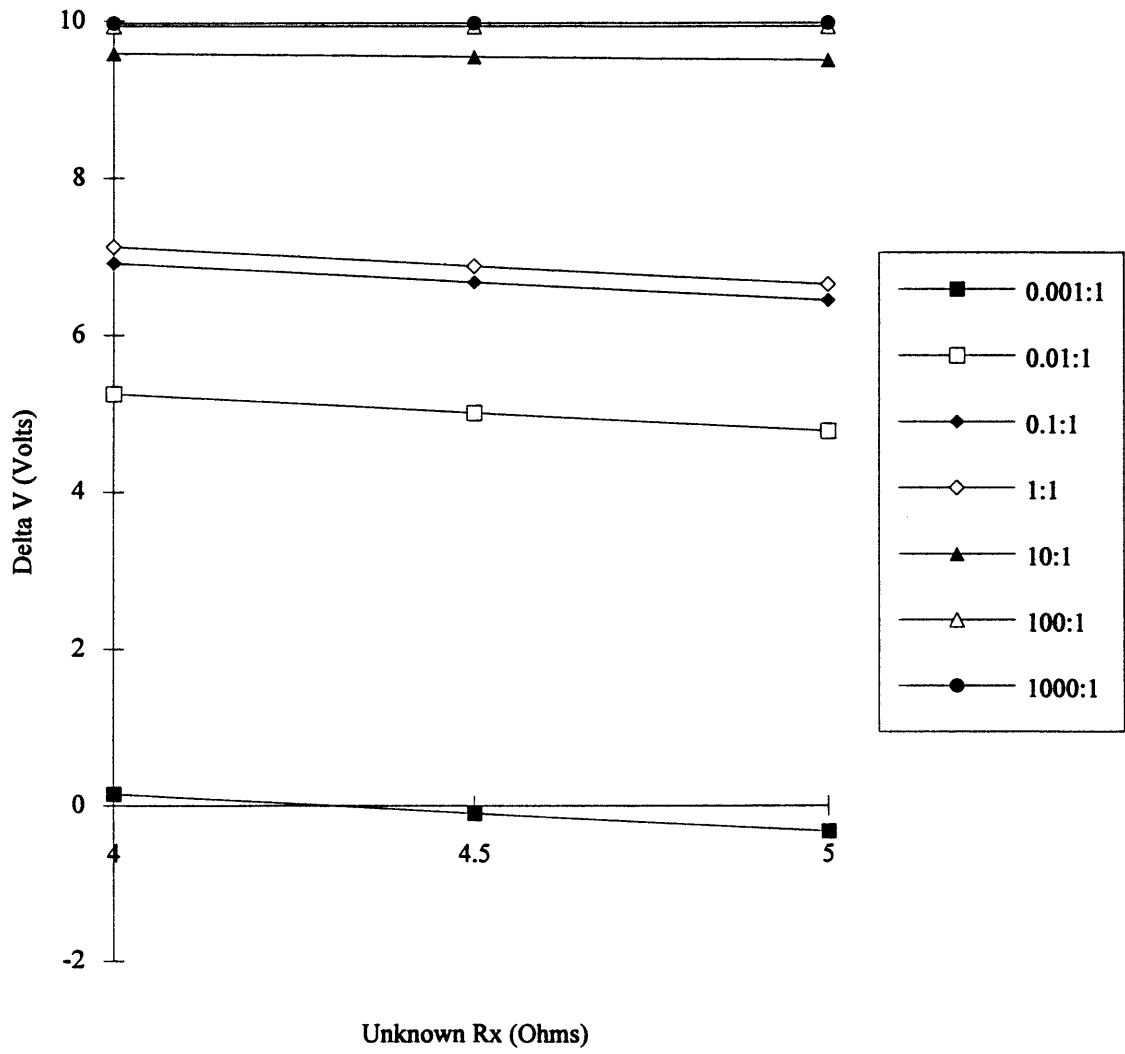

## Problem 4-79

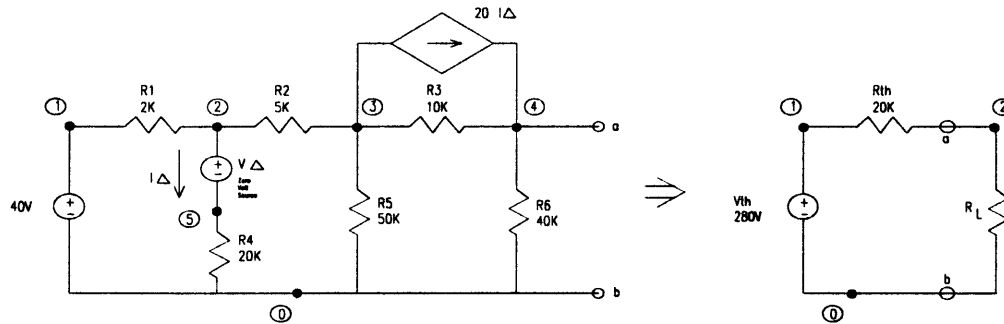

**Figure 1** Circuit with P-SPICE nodes indicated and equivalent circuit

This problem requires the value of  $R_L$  and the maximum power transferred from the circuit to be found. The problem was solved in two steps. First, the original circuit was analyzed to find the Thevenin equivalent (Figure 1) using the transfer function (.TF) analysis. The output file is shown below:

```
***** 03/02/93 ***** Evaluation PSpice (July 1989) ***** 00:31:33 *****
Problem 4-79 -- Max. pwr. xfer. 4-79a.cir finds Thevenin equiv. 4-79b vaires Ro.
****  CIRCUIT DESCRIPTION
*****
* Resistors
R1  1  2  2000
R2  2  3  5000
R3  3  4  10000
R4  5  0  20000
R5  3  0  50000
R6  4  0  40000
* Independent source
V1  1  0  DC  40
* Current control source
Videlta 2  5  DC  0
* Dependent source
F1  3  4  Videlta 30
* Analysis tools
.TF  V(4,0) V1
.PROBE
.END
```

```
***** 03/02/93 ***** Evaluation PSpice (July 1989) ***** 00:31:33 *****
Problem 4-79 -- Max. pwr. xfer. 4-79a.cir finds Thevenin equiv. 4-79b vaires Ro.
****  SMALL SIGNAL BIAS SOLUTION  TEMPERATURE = 27.000 DEG C
*****
NODE VOLTAGE  NODE VOLTAGE  NODE VOLTAGE  NODE VOLTAGE
( 1) 40.0000 ( 2) 24.0000 ( 3) -10.0000 ( 4) 280.0000
( 5) 24.0000
```

VOLTAGE SOURCE CURRENTS  
 NAME CURRENT  
 V1 -8.000E-03  
 Videlta 1.200E-03  
 TOTAL POWER DISSIPATION 3.20E-01 WATTS

\*\*\*\* SMALL-SIGNAL CHARACTERISTICS

V(4,0)/V1 = 7.000E+00

INPUT RESISTANCE AT V1 = 5.000E+03  
 OUTPUT RESISTANCE AT V(4,0) = 2.000E+04

JOB CONCLUDED  
 TOTAL JOB TIME 1.65

It is known that maximum power is transferred (to the load) when the source resistance equals the load resistance. The power transferred to the load is therefore 1/2 the total power. The P-SPICE analysis gives the equivalent source resistance (Rth) as 20KΩ. It is expected that the load resistor should also equal 20KΩ, which would yield maximum power transfer. To prove this, a second analysis was run, varying the load around the theoretical 20KΩ value. Load power VS load resistance are shown graphically on the next page. The graph shows that maximum power is developed in the resistor when it's value equals the source resistance of 20KΩ.

**Final results:**  $R_L=20K\Omega$  Power  $R_L=0.98w$   
 The power on  $R_L$  represents 50% of the total power developed in the circuit.

Shown below is a copy of the output file from the second analysis, with only the value of  $R_L=20K\Omega$  shown:

```

***** 03/02/93 ***** Evaluation PSpice (July 1989) ***** 20:13:16 *****
Problem 4-79 -- Max. pwr. xfer. This pgm. varies Ro. 4-79a.cir is Thev. equiv.
**** CIRCUIT DESCRIPTION
*****
* Resistors
R1 1 2 20000
* Output resistor defined as a variable model
Ro 2 0 Rmod 1
* Independent source
V1 1 0 DC 280
* Analysis tools
.MODEL Rmod RES(R=1)
*
R-init R-final Increment
.STEP LIN RES Rmod(R) 15000 25000 500
.PROBE
.END

**** Resistor MODEL PARAMETERS
Rmod
R 1

**** CURRENT STEP RMOD R = 20.0000E+03

NODE VOLTAGE NODE VOLTAGE NODE VOLTAGE NODE VOLTAGE
( 1) 280.0000 ( 2) 140.0000

```

TOTAL POWER DISSIPATION 1.96E+00 WATTS

Data and graphical analysis of load power VS load resistance.			V load	R load	P load
			120	15000	0.96
			122.25	15500	0.964198
			124.44	16000	0.967832
			126.58	16500	0.97106
			128.65	17000	0.973578
			130.67	17500	0.975694
			132.63	18000	0.977262
			134.55	18500	0.978579
			136.41	19000	0.979352
			138.23	19500	0.979873
			140	20000	0.98
			141.73	20500	0.979873
			143.41	21000	0.979354
			145.06	21500	0.978716
			146.67	22000	0.977822
			148.24	22500	0.976671
			149.77	23000	0.975263
			151.26	23500	0.973599
			152.73	24000	0.971936
			154.16	24500	0.970012
			155.56	25000	0.967957

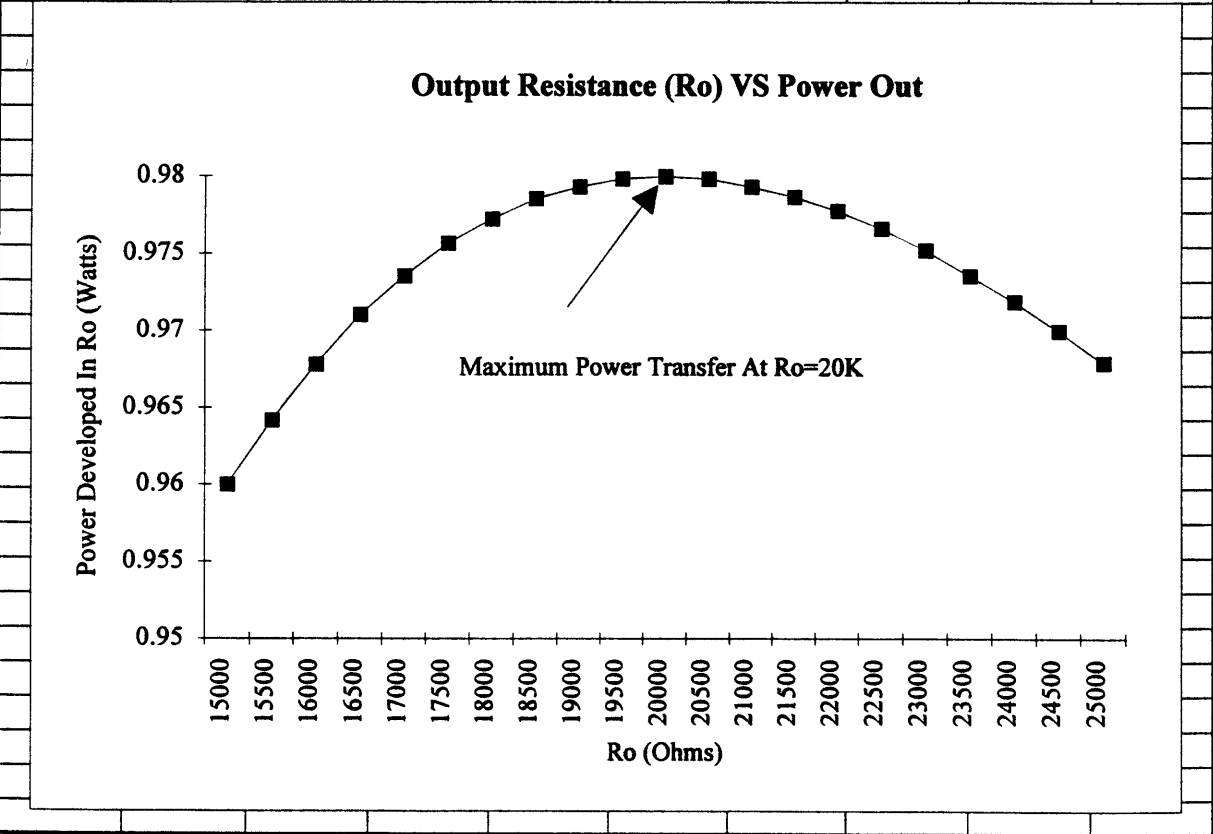

100

**CIRCUITS, SIGNALS AND SYSTEMS**  
**EEAP244**

**SPRING TERM 1993**

**MUHAMMADIAH MUHAMMAD**

*294-94-9800*

*muhamm@snowhite*

**PSPICE ASSIGNMENT #1**

PSPICE HOMEWORK

P3-53:

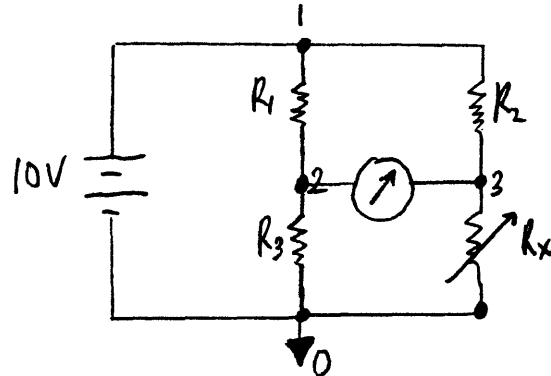

figure1

$$\frac{R_x}{R_3} = \frac{R_2}{R_1} \quad \text{Equation 1}$$

The main idea in solving this problem is to find the value of  $R_x$ , by adjusting the ratio of  $R_2/R_1$  to certain value. However as suggested in the question, the value of  $R_3$  is lying between 1 to 11,110 ohm. In order to get the value of correct  $R_3$  we use the characteristics of a wheatstone bridge; when  $I_g = 0$ .







Why I choose  $R_3 = 4000 \text{ ohm}$ . It is obvious, because in order to get the unknown resistor in 4 significant figure, the value of  $R_3$  must lay between 4000 - 5000 ohm. From equation 1,  $R_x$  will only vary between 4 till 5 ohm. If  $R_x = 4$ ,  $R_3 = 4000$  then the ratio will produce a 4 sig. figure value of  $R_x$ .

From the graph, I conclude that the ~~only~~ ratio of  $R_2/R_1$  by using the given value of  $R_x$  is 1/1000. This is because the wheatstone bridge will have a zero voltage different at node 2 and 3. Please refer to the given graph.

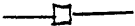
Problem 3.53 Wheatstone Bridge

```
V1 1 0 DC 10V
R1 1 2 1
R2 1 3 1000
R 2 0 4000
Rx 3 0 Rmod 1
.MODEL Rmod RES(R=1)
.STEP LIN RES Rmod(R) 4,5,0.2
.PRINT DC V(2),V(3),V(3,2)
.END
```

KEY FOR PROB 3-53

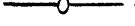
	0.001
	0.01
	0.1
	1
	10
	100
	1000

Ratio table (Key for P3-53 graph)  
( $R_2/R_1$ )



Data from output P3.53

Rx (Ohm)	Vdelta (V)						
4	0	1.7561	1.9751	1.9975	7.1404	9.6129	9.9577
4.2	-0.0769	1.6792	1.8941	1.9206	7.0398	9.5944	9.9557
4.4	-0.1481	1.608	1.827	1.8494	6.9419	9.576	9.9535
4.6	-0.2143	1.5418	1.7608	1.7832	6.8468	9.5577	9.9517
4.8	-0.2759	1.4802	1.6992	1.7216	6.7543	9.5395	9.9497
5	-0.3333	1.4228	1.6418	1.6642	6.6642	9.5213	9.9472

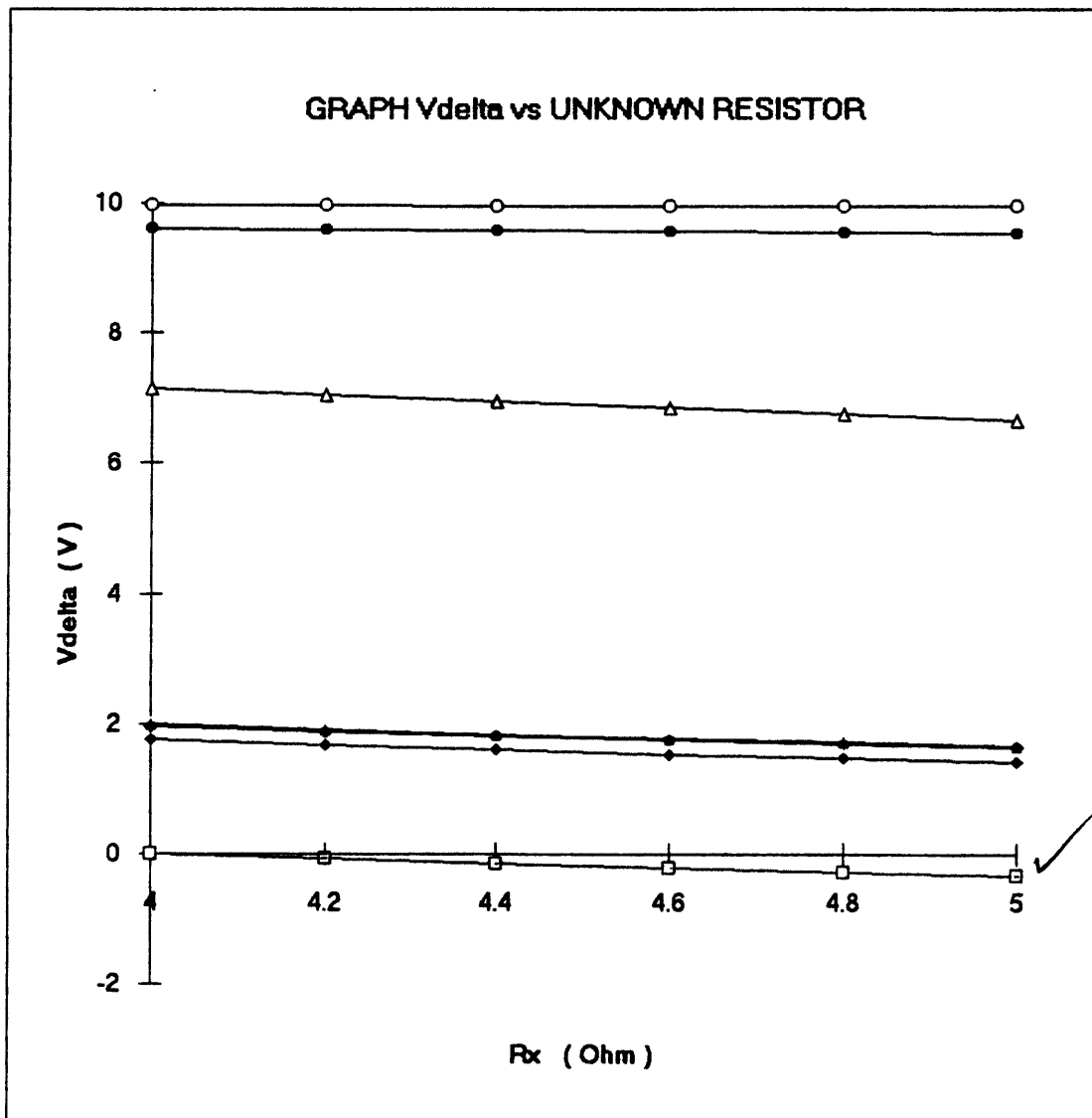

P4-79:

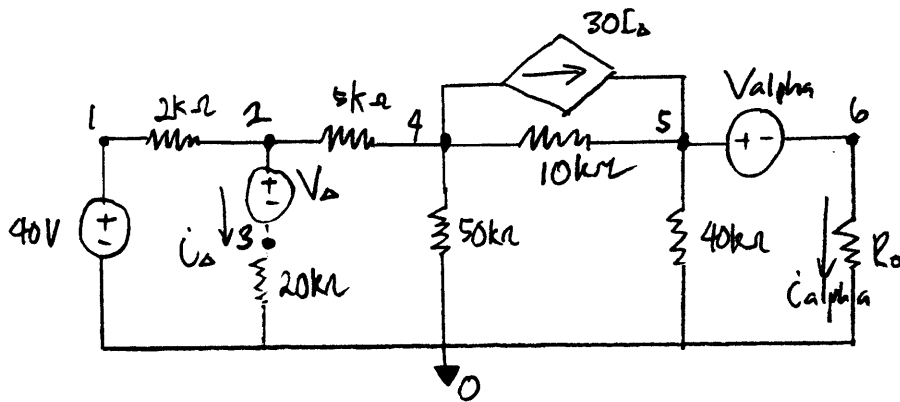

figure 2

- a) by using pspice the  $R_o$  is 20k, which is the  $R_{th}$
- b) the maximum power to  $R_o$  is 0.98 W  
 $P=vi$        $v=140V, i=7.0e-3$
- c)  $\% = (\text{total power dissipated}/\text{power at } R_o) \times 100\%$   
 $= (0.432/0.98) \times 100\% = 44.08 \%$

\*Problem 4.79 ; Find value of Ro

```
' 1 0 DC 40
RT 1 2 2k
R2 3 0 20k
R3 2 4 5k
R4 4 0 50k
R5 4 5 10k
F1 4 5 Vdelta 30
Vdelta 2 3 DC 0
Valpha 5 6 DC 0
R6 5 0 40k
R7 6 0 Rmod 1
.MODEL Rmod RES(R=1)
.STEP RES Rmod(R) 25k 45k 5k
.PROBE
.END
```

Data From output file Problem 4.79

Ro (kOhm)	Power (W)
15	0.96
16	0.9678
17	0.9736
18	0.9772
19	0.9793
20	0.98
21	0.9793
22	0.9768
23	0.9753
24	0.9719
25	0.9678

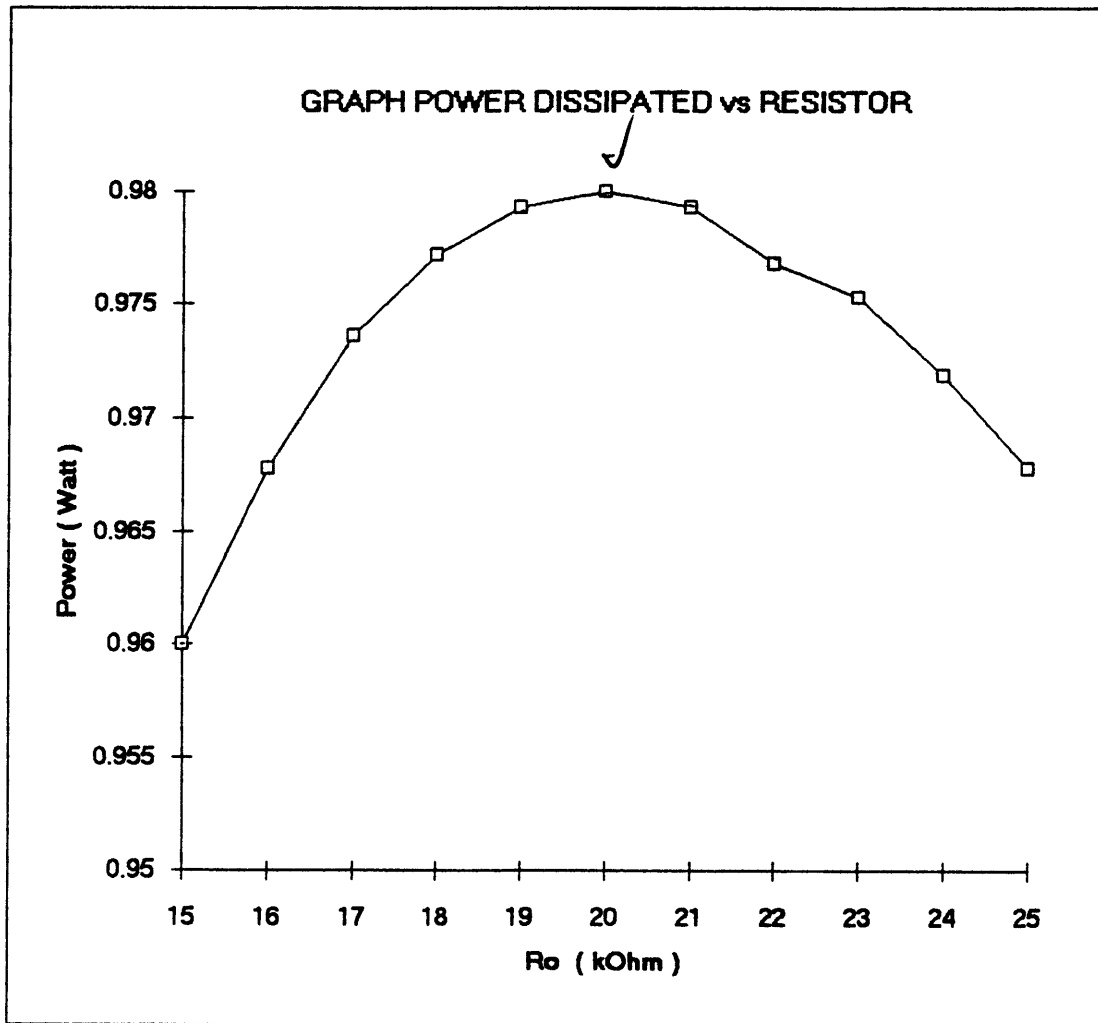

100

Dale Higginbotham  
295 - 60 - 4803  
3 - 5 - 93

Pspice problems:

### 3.53 Wheatstone Bridge:

For the Wheatstone bridge to work effectively there should be no current between the two branches. For this to happen (as proved in the textbook) the Ratio of  $R_3 / R_1$  has to be equal to  $R_x / R_2$ . I was given seven values for a ratio of  $R_2$  to  $R_1$  that varied between .001 to 1000. I was also given that  $R_x$  lied between 4 and 5 volts.

Therefore I implemented the program on the following page 21 times. Each time I implemented the program I changed  $R_x$  and  $R_1$ .  $R_x$  was changed from the 4 to the exact ratio that gives the answer (4.567) and then changed again to 5.  $R_1$  was changed by a factor of ten to accommodate each ratio. I also changed  $R_x$  from 4-5 to 40-50 to 400-500, etc., because when I divided  $R_1$  by 10 I had to multiply  $R_x$  by 10 so as to keep the same ratio.

To get 4 significant digits I used the ratio of .001. This ratio therefore gives the value of  $R_x$  between 4 and 5 volts and not 400 and 500 volts. For the actual value of  $R_x$  one could pick any number between 4 and 5 volts as long as it had 4 significant digits. I then got  $R_3$  by dividing  $R_x$  by .001 to get 4567 ohms.

\*Note: The program on the following page gives the correct ratio and values for  $R_x$  and  $R_3$ . This program was used in all of the calculations.

### 4.79 Circuit to find Maximum Power through a load Resistance

a.) To find the value of the load resistance at which the maximum power is delivered to it, I used the program on the following pages. This program generated an output file from which I took the values of the voltage at node a and the current through that branch and multiplied them to find the power at different resistances (values in table after program). The maximum power occurs when the load resistance is given a value of **20 kohms** as seen by the table and the graph.

b.) The maximum power at this resistance value is **.980 watts**.

c.) To find the total percentage of power delivered to  $R_o$ , I used KCL and KVL around the circuit to find the total power. Then I divided this value into the .98 watts (power dissipated by resistor) to get the percentage of total power developed in the circuit. This percentage is equal to **19.02 percent**.

```
Pspice problem 3.53 from text
Vin      1      0      DC      10
R1       1      2      1000k
F        1      3      1k
h        2      0      4567
Rx       3      0      4.567
.probe
.end
```

Graph for Problem 3.53

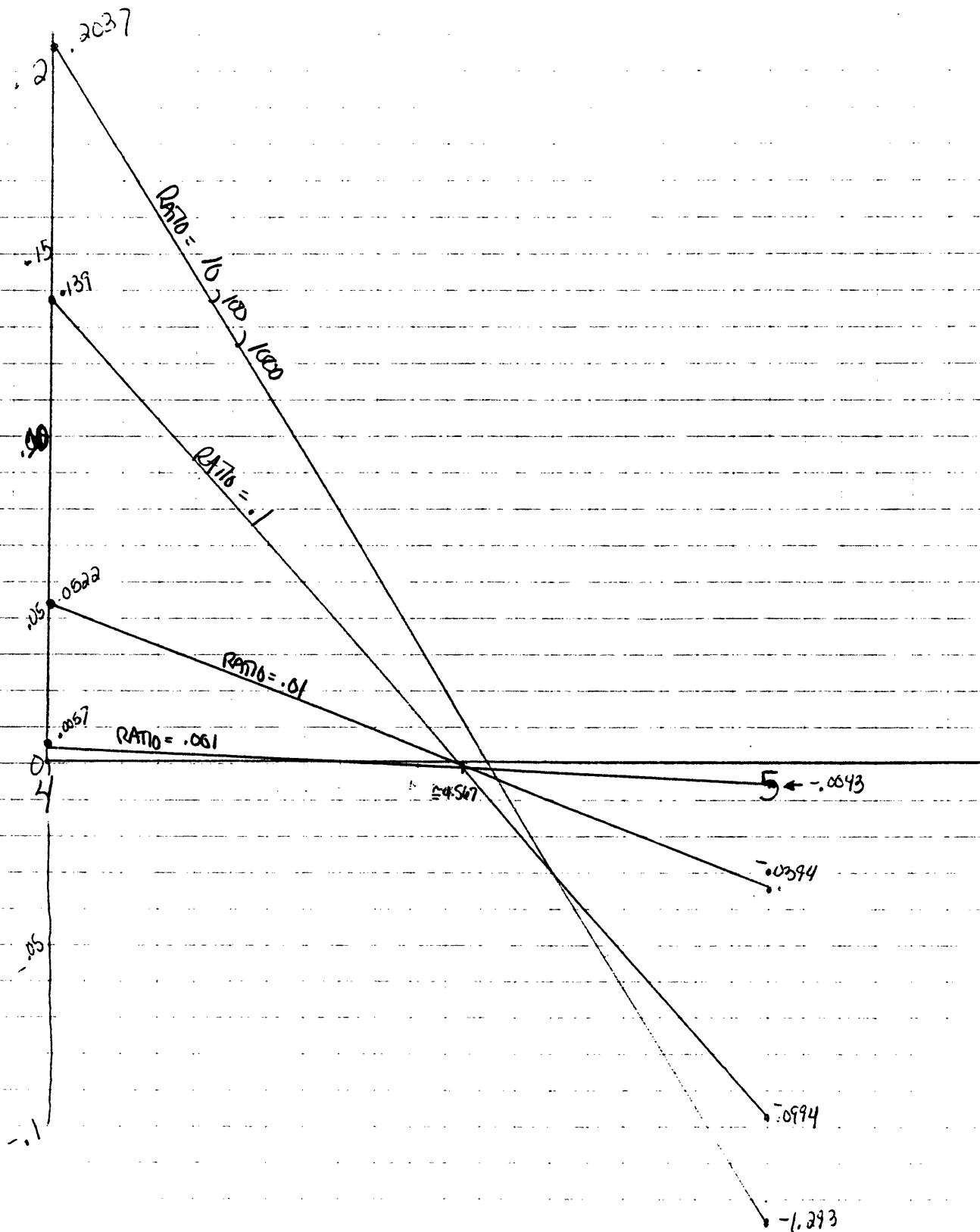

\* the ratio of 1 was not drawn because of computer simulation errors (I did not use the same value for  $U_{in}$ )

\* not drawn to scale

Pspice problem 4.79 from text

```
Vs      1      0      DC      40
Vdelta  2      3      DC      0
Vmeter 5      6      DC      0
V       4      5      Vdelta 30
R1      1      2      2k
R2      3      0      20k
R3      2      4      5k
R4      4      5      10k
R5      4      0      50k
R6      5      0      40k
R0      6      0      Rmod 1
.model  Rmod Res(R=1)
.step  lin Res Rmod(R) 2k,100k,2k
.probe
.end
```



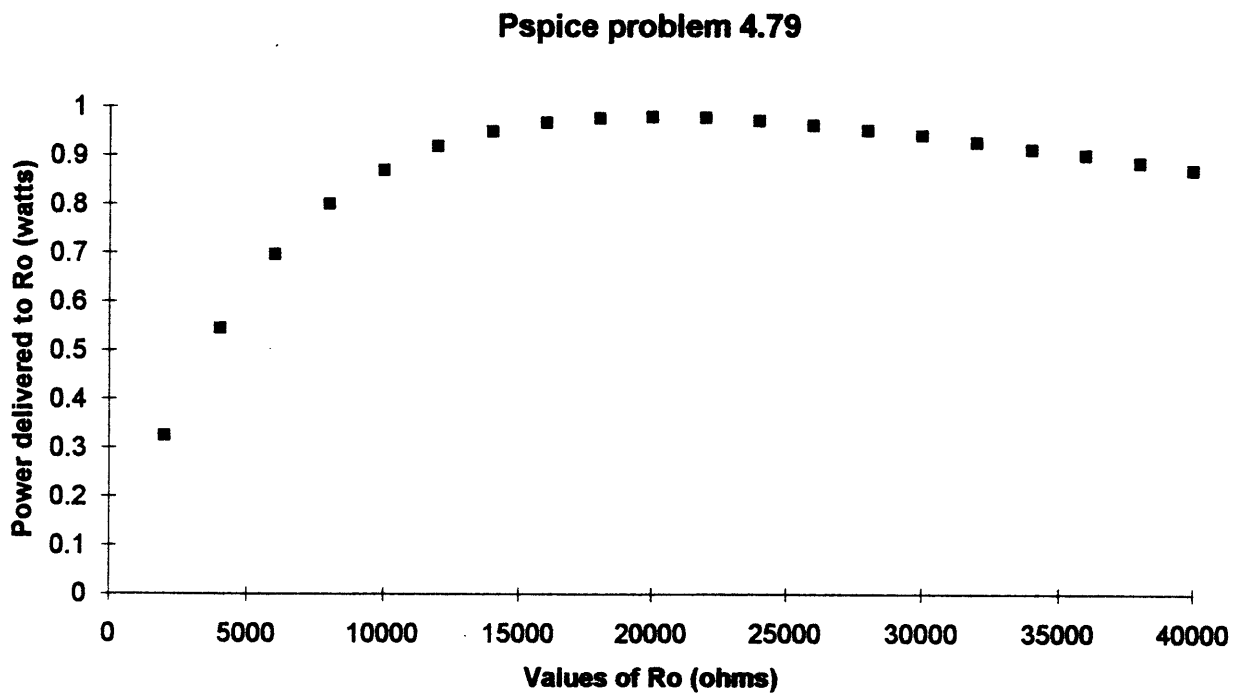

$R_o$	Power
2000	0.324
4000	0.5446
6000	0.6959
8000	0.8
10000	0.8704
12000	0.91875
14000	0.9488
16000	0.967583
18000	0.9772
20000	0.98
22000	0.9778
24000	0.9719
26000	0.9622
28000	0.9522
30000	0.9408
32000	0.92707
34000	0.91256
36000	0.9
38000	0.884229
40000	0.86988

For part A:  $R_o = 20k\Omega = R_{TH}$

part B:  $P = .980 \text{ WATTS}$

part C: % of total power delivered

to  $R_o$ : 19.02%

# INS TCP/IP PrintServer 20

<i>Print engine name:</i>	PrintServer 20
<i>Print engine version:</i>	17
<i>Printer firmware version:</i>	32
<i>Server Adobe PostScript version:</i>	48.3
<i>Server software version:</i>	V2.0
<i>Server network node:</i>	crawford
<i>Server name:</i>	crawford
<i>Server job number:</i>	86
<i>Client software version:</i>	WRL-1.0
<i>Client network node:</i>	util
<i>Client name:</i>	flm
<i>Client job name:</i>	pspice_hw2.ps.735168793
<i>Submitted at:</i>	Sun Apr 18 17:53:57 1993X
<i>Printed at:</i>	Sun Apr 18 17:53:58 1993

**flm@util**  
**pspice\_hw2.ps.735168793**

# PSpice HW #2:

Due: March 12, 1993

Phasor analysis  
Reference Conant, Chapter 5.

- The voltage source in the circuit shown is  $119\cos(800t+0.7^\circ)$  and the current source is  $4.27\cos(800t+41.9^\circ)$ . Find the current flowing downward through the 16 ohm resistor.

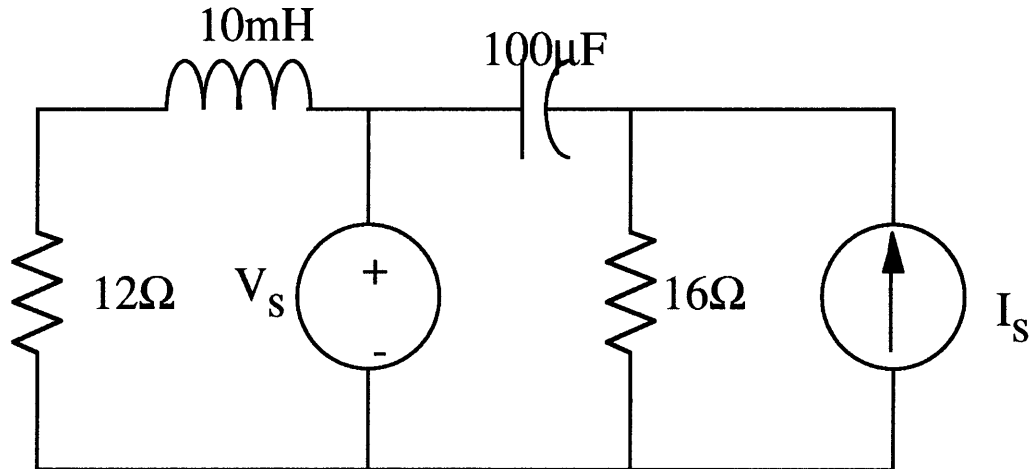

Solution:

The answer is  $7.162 + j3.204$  amps.

```
**** 03/17/93 11:16:44 ***** Evaluation PSpice (Jan 1993)
Problem 5-1
```

```
****      CIRCUIT DESCRIPTION
```

```
*****
```

```
R10 1 0 12
L12 1 2 10m
V20 2 0 ac 119 0.7
C23 2 3 100u
R30 3 0 16
I03 0 3 ac 4.27 41.9
.ac lin 1 127.3 127.3
.print ac IM(R30) IP(R30) IR(R30) II(R30)
.end
```

```
**** 03/17/93 11:16:44 ***** Evaluation PSpice (Jan 1993)
Problem 5-1
```

```
****      SMALL SIGNAL BIAS SOLUTION      TEMPERATURE = 27.000 DEG C
```

```
*****
```

NODE	VOLTAGE	NODE	VOLTAGE	NODE	VOLTAGE	NODE	VOLTAGE
( 1)	0.0000	( 2)	0.0000	( 3)	0.0000		

VOLTAGE SOURCE CURRENTS  
NAME          CURRENT  
V20          0.000E+00

TOTAL POWER DISSIPATION 0.00E+00 WATTS

\*\*\*\* 03/17/93 11:16:44 \*\*\*\*\* Evaluation PSpice (Jan 1993)  
Problem 5-1

\*\*\*\* AC ANALYSIS                          TEMPERATURE = 27.000 DEG C

\*\*\*\*\*

FREQ	IM(R30)	IP(R30)	IR(R30)	II(R30)
1.273E+02	7.846E+00	2.410E+01	7.162E+00	3.204E+00

JOB CONCLUDED

TOTAL JOB TIME .87

\*\*\*\* 03/17/93 11:16:45 \*\*\*\*\* Evaluation PSpice (Jan 1993)  
\* 7.162 +j3.204

\*\*\*\* CIRCUIT DESCRIPTION

\*\*\*\*\*

WARNING -- There are no devices in this circuit, (this message will be printed if there are blank lines after the last .END statement)

**COMMENTS:**

1. You lost 5 points if you did not label your answer. This will happen on all future PSpice homeworks.
2. You also lost 3 points for the wrong direction of a source, and 10 points for the wrong answer or no answer.
3. Labeled nodes are a big plus if your answer is wrong.

2. This op amp circuit is a low pass filter with a cutoff frequency of  $\omega=1000/s$ . Find the output voltage when the input voltage is a unit sinusoid of that frequency.

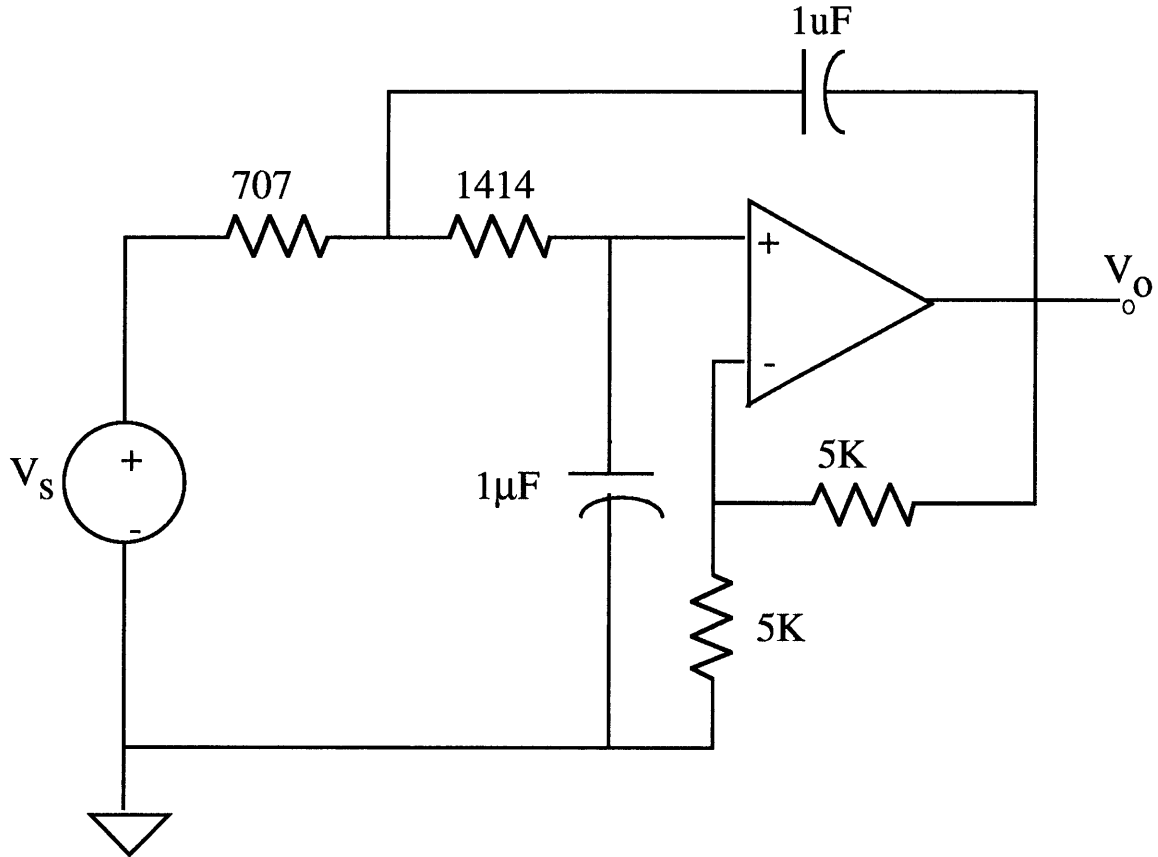

Solution:

The answer is  $-j1.414$

\*\*\*\* 03/17/93 11:21:12 \*\*\*\*\* Evaluation PSpice (Jan 1993)  
 Problem 5-5

\*\*\*\* CIRCUIT DESCRIPTION

\*\*\*\*\*

```
V10 1 0 ac 1
R12 1 2 707
R23 2 3 1414
C30 3 0 1u
C24 2 4 1u
R45 4 5 5k
R50 5 0 5k
R35 3 5 1e7
E60 6 0 3 5 1e5
R64 6 4 100
.ac lin 1 .159k .159k
.print ac VM(4) VP(4)
.end
```

\*\*\*\* 03/17/93 11:21:12 \*\*\*\*\* Evaluation PSpice (Jan 1993)  
Problem 5-5

\*\*\*\* SMALL SIGNAL BIAS SOLUTION TEMPERATURE = 27.000 DEG C

\*\*\*\*\*

NODE	VOLTAGE	NODE	VOLTAGE	NODE	VOLTAGE	NODE	VOLTAGE
( 1)	0.0000	( 2)	0.0000	( 3)	0.0000	( 4)	0.0000
( 5)	0.0000	( 6)	0.0000				

VOLTAGE SOURCE CURRENTS  
NAME CURRENT

V10 0.000E+00

TOTAL POWER DISSIPATION 0.00E+00 WATTS

\*\*\*\* 03/17/93 11:21:12 \*\*\*\*\* Evaluation PSpice (Jan 1993)  
Problem 5-5

\*\*\*\* AC ANALYSIS TEMPERATURE = 27.000 DEG C

\*\*\*\*\*

FREQ	VM(4)	VP(4)
1.590E+02	1.416E+00	-8.991E+01

JOB CONCLUDED

TOTAL JOB TIME .90

\*\*\*\* 03/17/93 11:21:13 \*\*\*\*\* Evaluation PSpice (Jan 1993)  
\* -j sqrt(2)

\*\*\*\* CIRCUIT DESCRIPTION

\*\*\*\*\*

COMMENTS:

1. You could have also used a LM318 or uA741 from the PSpice library with a slight change in the numerical value of the answers.
2. PSpice works in linear frequency (Hz). Several of you used specified radians/second in the problem. You lost five points for the failure to convert your numbers.
3. Several of you used AC power supplies and/or reversed the polarity of the power supply. You lost 3 to 5 points depending upon the severity of the error.

3. Determine the Thevenin equivalent circuit at the terminals, at a frequency  $\omega=10/s$ . Attach this Thevenin equivalent circuit, including an AC source, to the original circuit and show that the terminal voltage is the same for the original circuit and for its Thevenin equivalent.

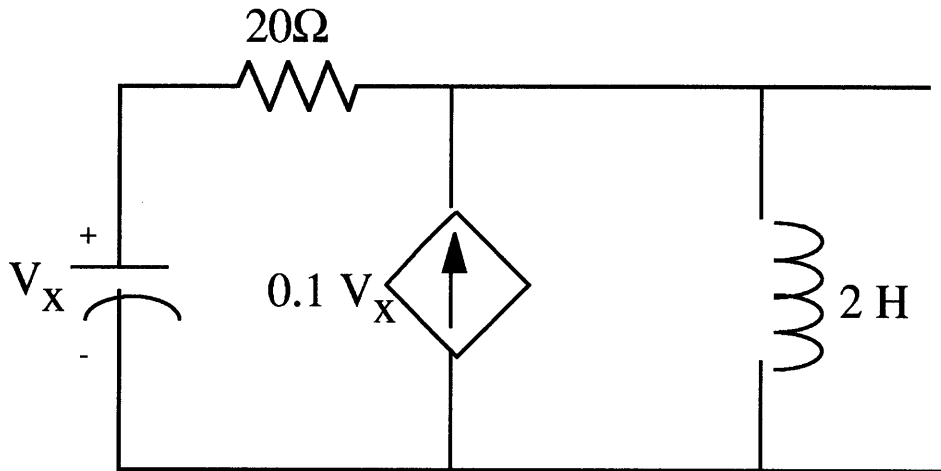

Solutions:

```
**** 03/17/93 11:25:54 ***** Evaluation PSpice (Jan 1993)
Problem 5-6: original ckt
```

```
****      CIRCUIT DESCRIPTION
```

```
*****
```

```
C10 1 0 .01
R12 1 2 20
G02 0 2 1 0 .1
L20 2 0 2
I02 0 2 ac 1
.ac lin 1 1.5915 1.5915
.print ac VR(2) VI(2)
.end
```

```
**** 03/17/93 11:25:54 ***** Evaluation PSpice (Jan 1993)
Problem 5-6: original ckt
```



\*\*\*\* SMALL SIGNAL BIAS SOLUTION TEMPERATURE = 27.000 DEG C

\*\*\*\*\*

NODE	VOLTAGE	NODE	VOLTAGE	NODE	VOLTAGE	NODE	VOLTAGE
( 1)	0.0000	( 2)	0.0000				

VOLTAGE SOURCE CURRENTS  
NAME CURRENT

TOTAL POWER DISSIPATION 0.00E+00 WATTS

\*\*\*\* 03/17/93 11:25:54 \*\*\*\*\* Evaluation PSpice (Jan 1993)  
Problem 5-6: original ckt

\*\*\*\* AC ANALYSIS TEMPERATURE = 27.000 DEG C

\*\*\*\*\*

FREQ	VR(2)	VI(2)
1.592E+00	4.000E+01	-2.000E+01

JOB CONCLUDED

TOTAL JOB TIME .85

\*\*\*\* 03/17/93 11:25:55 \*\*\*\*\* Evaluation PSpice (Jan 1993)  
Problem 5-6: TEC with new load ckt

\*\*\*\* CIRCUIT DESCRIPTION

\*\*\*\*\*

R10 1 0 40  
C12 1 2 .005  
R20 2 0 1e10  
L23 2 3 1  
R34 3 4 5  
V40 4 0 ac 4  
.ac lin 1 1.5915 1.5915

.print ac VR(2) VI(2)  
.end

\*\*\*\* 03/17/93 11:25:55 \*\*\*\*\* Evaluation PSpice (Jan 1993)  
Problem 5-6: TEC with new load ckt

\*\*\*\* SMALL SIGNAL BIAS SOLUTION TEMPERATURE = 27.000 DEG C

\*\*\*\*\*

NODE	VOLTAGE	NODE	VOLTAGE	NODE	VOLTAGE	NODE	VOLTAGE
( 1)	0.0000	( 2)	0.0000	( 3)	0.0000	( 4)	0.0000

VOLTAGE SOURCE CURRENTS  
NAME CURRENT

V40 0.000E+00

TOTAL POWER DISSIPATION 0.00E+00 WATTS

\*\*\*\* 03/17/93 11:25:55 \*\*\*\*\* Evaluation PSpice (Jan 1993)  
Problem 5-6: TEC with new load ckt

\*\*\*\* AC ANALYSIS TEMPERATURE = 27.000 DEG C

\*\*\*\*\*

FREQ	VR(2)	VI(2)
1.592E+00	3.765E+00	-9.412E-01

JOB CONCLUDED

TOTAL JOB TIME .42

\*\*\*\* 03/17/93 11:25:55 \*\*\*\*\* Evaluation PSpice (Jan 1993)  
Problem 5-6: original ckt with new load ckt

\*\*\*\* CIRCUIT DESCRIPTION

\*\*\*\*\*

```

C10 1 0 .01
R12 1 2 20
G02 0 2 1 0 .1
L20 2 0 2
L23 2 3 1
R34 3 4 5
V40 4 0 ac 4
.ac lin 1 1.5915 1.5915
.print ac VR(2) VI(2)
.end

```

```

**** 03/17/93 11:25:55 ***** Evaluation PSpice (Jan 1993)
Problem 5-6: original ckt with new load ckt

```

```

**** SMALL SIGNAL BIAS SOLUTION TEMPERATURE = 27.000 DEG C

```

```

*****

```

NODE	VOLTAGE	NODE	VOLTAGE	NODE	VOLTAGE	NODE	VOLTAGE
( 1)	0.0000	( 2)	0.0000	( 3)	0.0000	( 4)	0.0000

```

VOLTAGE SOURCE CURRENTS
NAME          CURRENT

```

```

V40           0.000E+00

```

```

TOTAL POWER DISSIPATION 0.00E+00 WATTS

```

```

**** 03/17/93 11:25:55 ***** Evaluation PSpice (Jan 1993)
Problem 5-6: original ckt with new load ckt

```

```

**** AC ANALYSIS TEMPERATURE = 27.000 DEG C

```

```

*****

```

FREQ	VR(2)	VI(2)
1.592E+00	3.765E+00	-9.411E-01

```

JOB CONCLUDED

```

```

TOTAL JOB TIME .43

```

```

**** 03/17/93 11:25:55 ***** Evaluation PSpice (Jan 1993)
* 40 ohms in series with 0.005 F capacitor

```

\*\*\*\* CIRCUIT DESCRIPTION

\*\*\*\*\*

WARNING -- There are no devices in this circuit, (this message will be printed if there are blank lines after the last .END statement)

COMMENTS:

1. The Thevenin resistance (impedance) is measured by applying a voltage or current source to the circuit under test. Several of you applied this test source from the left, i.e. across the capacitor. This was incorrect and caused you to lose 10 points. It was to be applied across the inductor. There is no Thevenin equivalent voltage source because the circuit has no independent voltage sources. When I used a test source of 1A I got  $Z_{\text{thevenin}}=40-j20$  ohms which is a 40 ohm resistor in series with a  $0.005\mu\text{F}$  capacitor.
2. This circuit is easier to analyze if you use a current source. That way the voltage at the test node is exactly the impedance because the voltage divided by the current is the impedance and anything divided by 1 (a good choice of test current) will be unchanged.
3. You cannot use a voltage test source unless you put it in series with a resistor. The value of the resistor is immaterial. The reason for this is that you will otherwise end up with two voltage sources in parallel which you know from the first quiz is not allowed.
4. This was a tough problem. If you did not indicate how you were calculating the Thevenin impedance I deducted 30 points. A PSpice printout is NOT the answer to this problem. You must typically do additional calculations which had to be presented.
5. Some people used the .TF command. This was a good idea but it only computes the DC Thevenin. This was an AC Thevenin problem and you lost 10 points.
6. A lot of people used  $C=0.01\mu\text{F}$  since I gave this value in class. You did not lose any points for this and the corresponding results for  $C=0.01\mu\text{F}$  follow. Note that the equivalent impedance now becomes  $-8+j4$  ( $8.944-153\infty$ ) ohms which is a negative 8 ohm resistance in series with a 0.4 henry inductor.

\*\*\*\* 03/26/93 21:39:20 \*\*\*\*\* Evaluation PSpice (Jan 1993)  
\*\*\*\*\*

Problem 5-6: original ckt

```
**** CIRCUIT DESCRIPTION
*****
C10 1 0 .01u
R12 1 2 20
G02 0 2 1 0 .1
L20 2 0 2
I02 0 2 ac 1
.ac lin 1 1.5915 1.5915
.print ac VR(2) VI(2)
```

.end

```
**** 03/26/93 21:39:20 ***** Evaluation PSpice (Jan 1993)
*****
Problem 5-6: original ckt
****          AC ANALYSIS                      TEMPERATURE = 27.000 DEG C
*****
FREQ          VR(2)          VI(2)
1.592E+00    -8.000E+00     4.000E+00
```

```
**** 03/26/93 21:39:21 ***** Evaluation PSpice (Jan 1993)
*****
Problem 5-6: TEC with new source ckt
****          CIRCUIT DESCRIPTION
*****
R10 1 0 -8
L12 1 2 .4
L23 2 3 1
R34 3 4 5
V40 4 0 ac 4
.ac lin 1 1.5915 1.5915
.print ac VR(2) VI(2)
.end
```

```
**** 03/26/93 21:39:21 ***** Evaluation PSpice (Jan 1993)
*****
Problem 5-6: TEC with new source ckt
****          AC ANALYSIS                      TEMPERATURE = 27.000 DEG C
*****
FREQ          VR(2)          VI(2)
1.592E+00     1.561E+00     1.951E+00
```

JOB CONCLUDED

TOTAL JOB TIME .70

```
**** 03/26/93 21:39:22 ***** Evaluation PSpice (Jan 1993)
*****
Problem 5-6: original ckt with new source ckt
****          CIRCUIT DESCRIPTION
*****
C10 1 0 .01u
R12 1 2 20
G02 0 2 1 0 .1
L20 2 0 2
L23 2 3 1
R34 3 4 5
V40 4 0 ac 4
.ac lin 1 1.5915 1.5915
.print ac VR(2) VI(2)
.end
```

```
**** 03/26/93 21:39:22 ***** Evaluation PSpice (Jan 1993)
Problem 5-6: original ckt with new source ckt
****          AC ANALYSIS                      TEMPERATURE = 27.000 DEG C
*****
FREQ          VR(2)          VI(2)
```

1.592E+00 1.561E+00 1.951E+00

JOB CONCLUDED

TOTAL JOB TIME .43

\*\*\*\* 03/26/93 21:39:22 \*\*\*\*\* Evaluation PSpice (Jan 1993)  
\*\*\*\*\*

\* -8 ohms in series with 0.4H inductor

\*\*\*\* CIRCUIT DESCRIPTION

\*\*\*\*\*  
WARNING -- There are no devices in this circuit, (this message will be  
printed if there are blank lines after the last .END statement)

# INS TCP/IP PrintServer 20

Print engine name: PrintServer 20  
Print engine version: 17  
Printer firmware version: 32  
Server Adobe PostScript version: 48.3  
Server software version: V2.0  
Server network node: crawford  
Server name: crawford  
Server job number: 20  
Client software version: WRL-1.0  
Client network node: util  
Client name: flm  
Client job name: PSpice\_HW3.ps.734099538  
Submitted at: Tue Apr 6 09:09:04 1993X  
Printed at: Tue Apr 6 09:09:04 1993

- Vance  
- message  
- phone

tree lawn  
along drive  
back yard.

**flm@util**  
**PSpice\_HW3.ps.734099538**

# PSpice HW #3:

Due: April 2, 1993

Transient analysis

Reference: Conant, Chapter 4, 8.

4.7. At  $t=0^-$ , the capacitor voltage is 20 volts and the power dissipated by the resistor is 40 mW, and the current source is inactive. For  $t>0$ , the source injects 10 mA of current into the circuit. Demonstrate, using superposition with Probe, that the resistor current is the sum of current contributions arising from the current source and from the initial condition energy storage in the capacitor and inductor.

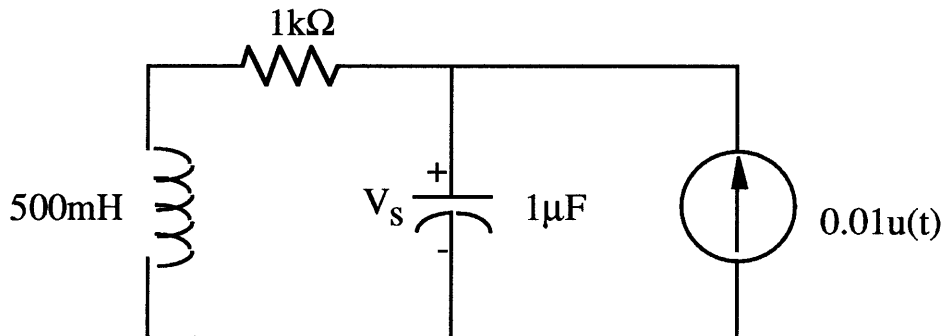

8.2. Calculate the inverse Laplace transform of

$$H(s) = \frac{s^2 + 8s + 13}{(s+1)(s+2)(s+3)},$$

by hand. Use PSpice and Probe to display your calculated  $f(t)$  and also to display the inverse transform directly, as the output of a Laplace-form E-source.

8.3. The pulse shown enters the system shown, with  $H_1(s) = \frac{5}{s^2 + s + 5}$  and

$H_2(s) = \frac{5}{s^2 + s + 10}$ . Display the output of the system,  $v_{out}(t)$ .

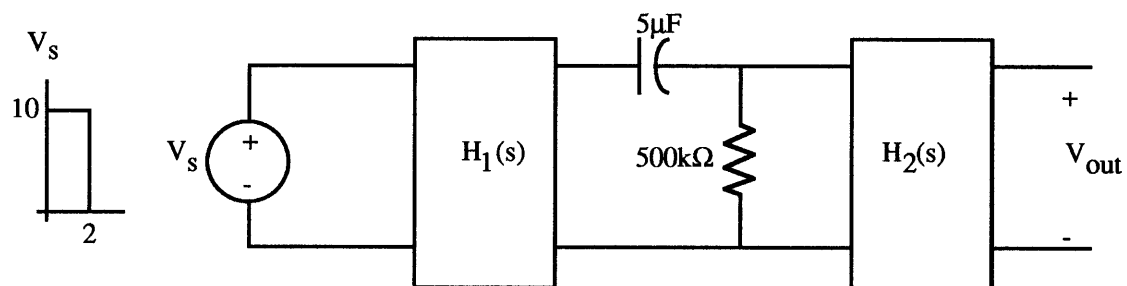



## PSpice HW #3:

Due: April 2, 1993

Transient analysis

Reference: Conant, Chapter 4, 8.

4.7. At  $t=0^-$ , the capacitor voltage is 20 volts and the power dissipated by the resistor is 40 mW, and the current source is inactive. For  $t>0$ , the source injects 10 mA of current into the circuit. Demonstrate, using superposition with Probe, that the resistor current is the sum of current contributions arising from the current source and from the initial condition energy storage in the capacitor and inductor.

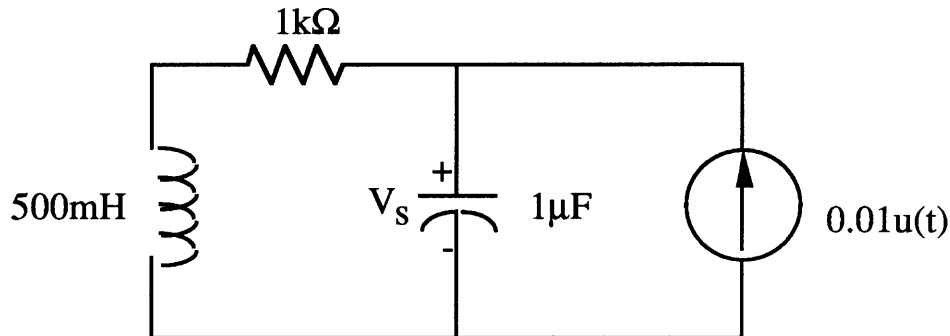

### Solutions:

Problem 4-7: capacitor IC only

```
L20 2 0 500m
```

```
R23 2 3 1K
```

```
C30 3 0 .1u IC = 20
```

```
.tran 6m 6m 0 .06m UIC
```

```
.probe
```

```
.end
```

Problem 4-7: inductor IC only

```
L20 2 0 500m IC = 6.31m
```

```
R23 2 3 1K
```

```
C30 3 0 .1u
```

```
.tran 6m 6m 0 .06m UIC
```

```
.probe
```

```
.end
```

Problem 4-7: CS only

```
I03 0 3 pw1 0,0 1u,10m
```

```
L20 2 0 500m
```

```
R23 2 3 1K
```

```
C30 3 0 .1u
```

```
.tran 6m 6m 0 .06m
```

```
.probe
```

```
.end
```

Problem 4-7: all IC's and source

```
I03 0 3 pw1 0,0 1u,10m
```

```
L20 2 0 500m IC = 6.31m
```

```
R23 2 3 1K
```

```
C30 3 0 .1u IC = 20
```

```
.tran 6m 6m 0 .06m UIC
```

```
.probe
```

.end

8.2. Calculate the inverse Laplace transform of

$$H(s) = \frac{s^2 + 8s + 13}{(s+1)(s+2)(s+3)},$$

by hand. Use PSpice and Probe to display your calculated  $f(t)$  and also to display the inverse transform directly, as the output of a Laplace-form E-source.

**Solution:**

Problem 8-2

```
V10 1 0 pwl 0,0 1m,1K 2m,0 ;impulse
R10 1 0 1
E20 2 0 Laplace {V(1)} = {(s*s+8*s+13)/((s+1)*(s+2)*(s+3))}
R20 2 0 1
E30 3 0 value = {3*exp(-time) - exp(-2*time) - exp(-3*time)}
R30 3 0 1
.tran 5 5
.probe
.end
```

8.3. The pulse shown enters the system shown, with  $H_1(s) = \frac{5}{s^2 + s + 5}$  and

$H_2(s) = \frac{5}{s^2 + s + 10}$ . Display the output of the system,  $v_{out}(t)$ .

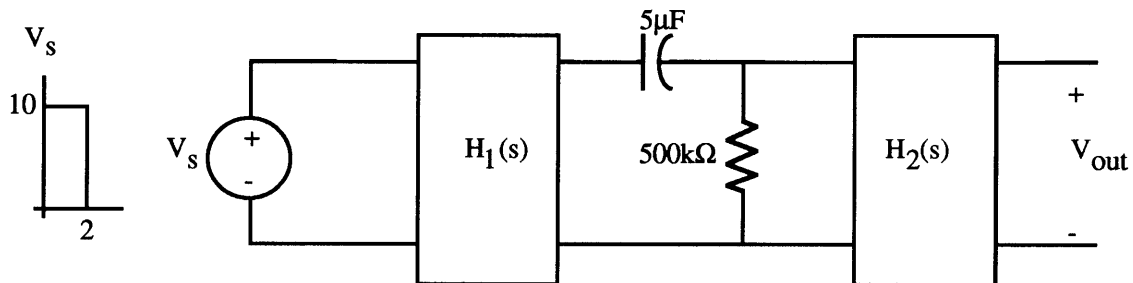

**Solution:**

Problem 8-3

```
V10 1 0 pwl 0,0 1m,1 2,1 2.001,0
R10 1 0 1
E20 2 0 Laplace {V(1)} = {25/((s*s+s+10)*(s*s+s+5))}
R20 2 0 1
C23 2 3 5u
R30 3 0 100k
.tran 10 10
.probe
.end
```

# INS TCP/IP PrintServer 20

*Print engine name:* PrintServer 20  
*Print engine version:* 17  
*Printer firmware version:* 32  
*Server Adobe PostScript version:* 48.3  
*Server software version:* V2.0  
*Server network node:* crawford  
*Server name:* crawford  
*Server job number:* 86  
*Client software version:* WRL-1.0  
*Client network node:* util  
*Client name:* flm  
*Client job name:* pspice\_hw4.ps.735168779  
*Submitted at:* Sun Apr 18 17:55:50 1993X  
*Printed at:* Sun Apr 18 17:55:50 1993

**flm@util**  
**pspice\_hw4.ps.735168779**

# PSpice HW #4:

Due: April 21, 1993

Frequency response  
Reference: Conant, Chapter 6.

6.7. Display the magnitude and phase angle plots for  $H(j\omega) = V_o(\omega)/V_s(\omega)$ . Find the frequency at which the magnitude is a maximum. Find the frequency at which the phase angle is zero. This network is used in a common oscillator circuit.

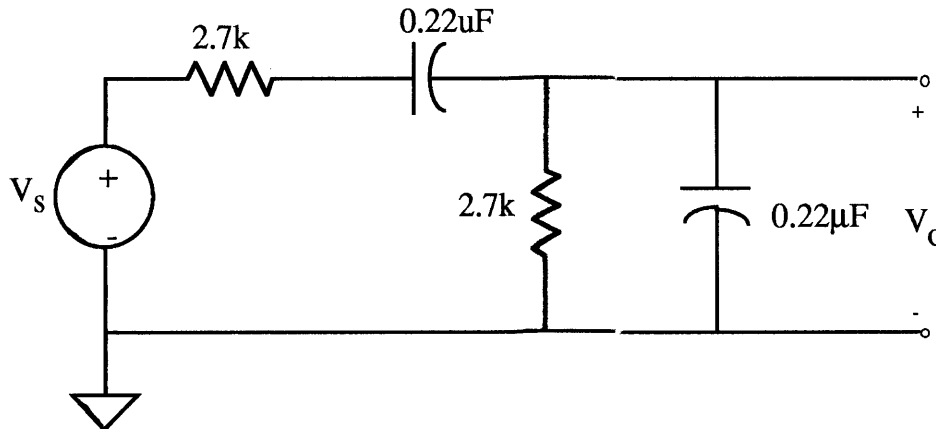

6.8. Determine the center frequency and bandwidth of this bandpass filter, where the bandwidth is defined as the difference in frequency between the upper and lower half-power frequencies. At these frequencies, the magnitude of the output is  $\frac{1}{\sqrt{2}}$  times the maximum, or 3dB lower than the maximum in dB units. Sharp second-order band pass filters like this one in the frequency domain correspond to underdamped resonant circuits in the time domain. Apply an impulse of voltage to this circuit and observe the transient response. How is the frequency of oscillation related to the center frequency of the filter? How is the damping related to the center frequency and bandwidth?

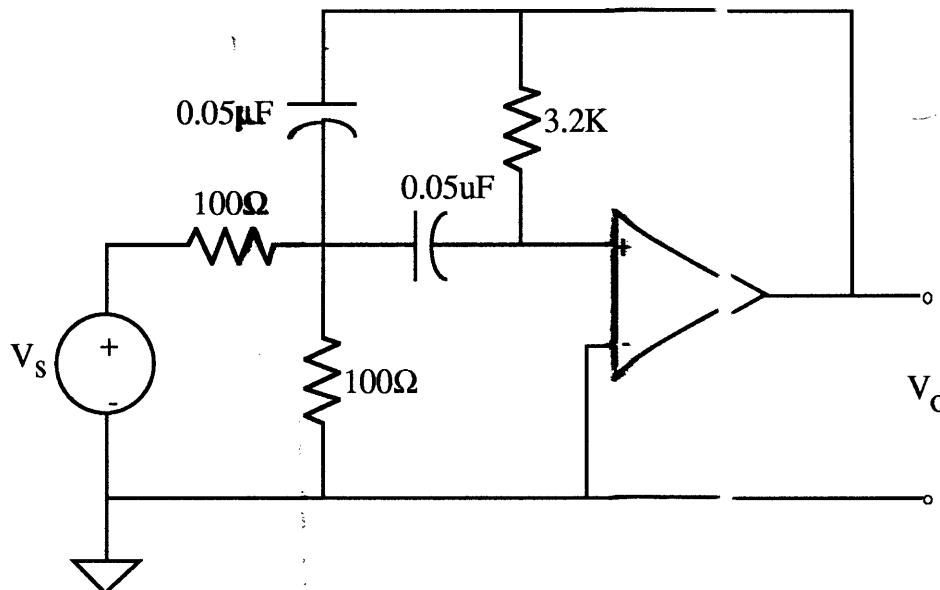

- \* Sample standard device library
- \*
- \* Copyright 1993 by MicroSim Corporation
- \* This is a reduced version of MicroSim's standard parts libraries. Some
- \* components from several types of component libraries have been included
- \* here. You are welcome to make as many copies of it as you find convenient.
- \*
- \* The Microsim library included with the production version of PSpice
- \* includes over 3,500 analog devices, and over 1,500 digital devices.
- \*
- \* Release date: January 1993
- \*
- \* It takes time for PSpice to scan a library file. To speed this up, PSpice
- \* creates an index file, called <filename>.IND. The index file is re-created
- \* whenever PSpice senses that the library file has changed.

\* The following is a summary of parts in this library:

Part name	Part type
-----	-----
* Q2N2222A	NPN bipolar transistor
* Q2N2907A	PNP bipolar transistor
* Q2N3904	NPN bipolar transistor
* Q2N3906	PNP bipolar transistor
* D1N750	zener diode
* MV2201	voltage variable capacitance diode
* D1N4148	switching diode
* MBD101	switching diode
* J2N3819	N-channel Junction field effect transistor
* J2N4393	N-channel Junction field effect transistor
* LM324	linear operational amplifier
* LF411	linear operational amplifier
* UA741	linear operational amplifier
* LM111	voltage comparator
* K3019PL_3C8	ferroxcube pot magnetic core
* KRM8PL_3C8	ferroxcube pot magnetic core
* K502T300_3C8	ferroxcube pot magnetic core
* IRF150	N-type power MOS field effect transistor
* IRF9140	P-type power MOS field effect transistor
* 7402	TTL digital 2-input NOR gate
* 7404	TTL digital inverter
* 7405	TTL digital inverter, open collector
* 7414	TTL digital inverter, schmidt trigger
* 7474	TTL digital D-type flip-flop
* 74107	TTL digital JK-type flip-flop
* 74393	TTL digital 4-bit binary counter
* A4N25	optocoupler

*D1N5229 zener.*

*D1N914 - switching diode  
D1N914A - switching diode*

*D1N4009 - power diode*

*J2N5457 - N-channel JFET  
LM318 linear op amp.*

```

*
*      2N1595      silicon controlled rectifier
*      2N5444      Triac
*
*      555D        555 timer subcircuit
*

```

```

*-----

```

```

* Library of bipolar transistor model parameters
*

```

```

* This is a reduced version of MicroSim's bipolar transistor model library.
* You are welcome to make as many copies of it as you find convenient.
*

```

```

* The parameters in this model library were derived from the data sheets for
* each part. Each part was characterize using the Parts option.

```

```

* Devices can also be characterized without Parts as follows:
*

```

```

*      NE, NC          Normally set to 4
*      BF, ISE, IKF    These are adjusted to give the nominal beta vs.
*                      collector current curve. BF controls the mid-
*                      range beta. ISE/IS controls the low-current
*                      roll-off. IKF controls the high-current rolloff.
*      ISC            Set to ISE.
*      IS, RB, RE, RC  These are adjusted to give the nominal VBE vs.
*                      IC and VCE vs. IC curves in saturation. IS
*                      controls the low-current value of VBE. RB+RE
*                      controls the rise of VBE with IC. RE+RC controls
*                      the rise of VCE with IC. RC is normally set to 0.
*      VAF            Using the voltages specified on the data sheet
*                      VAF is set to give the nominal output impedance
*                      (RO on the .OP printout) on the data sheet.
*      CJC, CJE        Using the voltages specified on the data sheet
*                      CJC and CJE are set to give the nominal input
*                      and output capacitances (CPI and CMU on the .OP
*                      printout; Cibo and Cobo on the data sheet).
*      TF              Using the voltages and currents specified on the
*                      data sheet for FT, TF is adjusted to produce the
*                      nominal value of FT on the .OP printout.
*      TR              Using the rise and fall time circuits on the
*                      data sheet, TR (and if necessary TF) are adjusted
*                      to give a transient analysis which shows the
*                      nominal values of the turn-on delay, rise time,
*                      storage time, and fall time.
*      KF, AF          These parameters are only set if the data sheet has
*                      a spec for noise. Then, AF is set to 1 and KF
*                      is set to produce a total noise at the collector
*                      which is greater than the generator noise at the
*                      collector by the rated number of decibels.
*

```

```

* $

```

```

.model Q2N2222A NPN(Is=14.34f Xti=3 Eg=1.11 Vaf=74.03 Bf=255.9 Ne=1.307
+      Ise=14.34f Ikf=.2847 Xtb=1.5 Br=6.092 Nc=2 Isc=0 Ikr=0 Rc=1
+      Cjc=7.306p Mjc=.3416 Vjc=.75 Fc=.5 Cje=22.01p Mje=.377 Vje=.75
+      Tr=46.91n Tf=411.1p Itf=.6 Vtf=1.7 Xtf=3 Rb=10)
*      National      pid=19      case=TO18

```

```

*          88-09-07 bam creation
*$
.model Q2N2907A PNP(Is=650.6E-18 Xti=3 Eg=1.11 Vaf=115.7 Bf=231.7 Ne=1.829
+          Ise=54.81f Ikf=1.079 Xtb=1.5 Br=3.563 Nc=2 Isc=0 Ikr=0 Rc=.715
+          Cjc=14.76p Mjc=.5383 Vjc=.75 Fc=.5 Cje=19.82p Mje=.3357 Vje=.75
+          Tr=111.3n Tf=603.7p Itf=.65 Vtf=5 Xtf=1.7 Rb=10)
*          National          pid=63          case=TO18
*          88-09-09 bam creation

```

```

*$
.model Q2N3904      NPN(Is=6.734f Xti=3 Eg=1.11 Vaf=74.03 Bf=416.4 Ne=1.259
+          Ise=6.734f Ikf=66.78m Xtb=1.5 Br=.7371 Nc=2 Isc=0 Ikr=0 Rc=1
+          Cjc=3.638p Mjc=.3085 Vjc=.75 Fc=.5 Cje=4.493p Mje=.2593 Vje=.75
+          Tr=239.5n Tf=301.2p Itf=.4 Vtf=4 Xtf=2 Rb=10)
*          National          pid=23          case=TO92
*          88-09-08 bam creation

```

```

*$
.model Q2N3906      PNP(Is=1.41f Xti=3 Eg=1.11 Vaf=18.7 Bf=180.7 Ne=1.5 Ise=0
+          Ikf=80m Xtb=1.5 Br=4.977 Nc=2 Isc=0 Ikr=0 Rc=2.5 Cjc=9.728p
+          Mjc=.5776 Vjc=.75 Fc=.5 Cje=8.063p Mje=.3677 Vje=.75 Tr=33.42n
+          Tf=179.3p Itf=.4 Vtf=4 Xtf=6 Rb=10)
*          National          pid=66          case=TO92
*          88-09-09 bam creation

```

```

*$
*-----

```

```

* Library of diode model parameters
*
* Copyright 1992 by MicroSim Corporation
* This is a reduced version of MicroSim's diode model library.
* You are welcome to make as many copies of it as you find convenient.
*
* The parameters in this model library were derived from the data sheets for
* each part. Most parts were characterize using the Parts option.
* Devices can also be characterized without Parts as follows:
*   IS          nominal leakage current
*   RS          for zener diodes: nominal small-signal impedance
*              at specified operating current
*   IB          for zener diodes: set to nominal leakage current
*   IBV         for zener diodes: at specified operating current
*              IBV is adjusted to give the rated zener voltage
*

```

```

*** Zener Diodes ***
*
* "A" suffix zeners have the same parameters (e.g., 1N750A has the same
* parameters as 1N750)
*

```

```

*$
.model D1N750      D(Is=880.5E-18 Rs=.25 Ikf=0 N=1 Xti=3 Eg=1.11 Cjo=175p
M=.5516
+          Vj=.75 Fc=.5 Isr=1.859n Nr=2 Bv=4.7 Ibv=20.245m Nbv=1.6989
+          Ibvl=1.9556m Nbv1=14.976 Tbv1=-21.277u)
*          Motorola          pid=1N750          case=DO-35
*          89-9-18 gjg

```

\* Vz = 4.7 @ 20mA, Zz = 300 @ 1mA, Zz = 12.5 @ 5mA, Zz = 2.6 @ 20mA

\*\$

.model D1N5229 D(Is=880.5E-18 Rs=.25 Ikf=0 N=1 Xti=3 Eg=1.11 Cjo=190p M=.6124

+ Vj=.75 Fc=.5 Isr=1.743n Nr=2 Bv=4.3 Ibv=16.748m Nbv=1.7936

+ Ibvl=5.0382m Nbv1=12.554 Tbv1=-232.56u)

\* Motorola pid=1N5229 case=DO-35

\* 89-9-18 gjg

\* Vz = 4.3 @ 20mA, Zz = 325 @ 1mA, Zz = 24 @ 5mA, Zz = 3.2 @ 20mA

\*\$

\*\*\* Voltage-variable capacitance diodes

\* The parameters in this model library were derived from the data sheets for each part. Each part was characterize using the Parts option.

\*\$

.model MV2201 D(Is=1.365p Rs=1 Ikf=0 N=1 Xti=3 Eg=1.11 Cjo=14.93p M=.4261

+ Vj=.75 Fc=.5 Isr=16.02p Nr=2 Bv=25 Ibv=10u)

\* Motorola pid=MV2201 case=182-03

\* 88-09-22 bam creation

\*\*\* Switching Diodes \*\*\*

\*\$

.model D1N914 D(Is=0.1p Rs=16 CJO=2p Tt=12n Bv=100 Ibv=0.1p)

\*\$

.model D1N914A D(Is=0.1p Rs=4 CJO=2p Tt=12n Bv=100 Ibv=0.1p)

\*\$

.model D1N4148 D(Is=0.1p Rs=16 CJO=2p Tt=12n Bv=100 Ibv=0.1p)

\*\$

.model MBD101 D(Is=192.1p Rs=.1 Ikf=0 N=1 Xti=3 Eg=1.11 Cjo=893.8f M=98.29m

+ Vj=.75 Fc=.5 Isr=16.91n Nr=2 Bv=5 Ibv=10u)

\* Motorola pid=MBD101 case=182-03

\* 88-09-22 bam creation

\*\*\* Power Diodes \*\*\*

\*\$

.model D1N4009 D(Is=0.1p Rs=4 CJO=2p Tt=3n Bv=60 Ibv=0.1p)

\* 85-??-?? Original library

\*\$

-----

\* Library of junction field-effect transistor (JFET) model parameters

\* This is a reduced version of MicroSim's JFET model library.

\* You are welcome to make as many copies of it as you find convenient.

\* The parameters in this model library were derived from the data sheets for each part. Each part was characterize using the Parts option.

\*\$

.model J2N3819 NJF(Beta=1.304m Betatce=-.5 Rd=1 Rs=1 Lambda=2.25m Vto=-3



```

+          Vtotc=-2.5m Is=33.57f Isr=322.4f N=1 Nr=2 Xti=3 Alpha=311.7
+          Vk=243.6 Cgd=1.6p M=.3622 Pb=1 Fc=.5 Cgs=2.414p Kf=9.882E-18
+          Af=1)
*          National      pid=50          case=TO92
*          88-08-01 rnm  BVmin=25
*$

```

```

.model J2N4393      NJF(Beta=9.109m Betatce=-.5 Rd=1 Rs=1 Lambda=6m Vto=-
1.422
+          Vtotc=-2.5m Is=205.2f Isr=1.988p N=1 Nr=2 Xti=3 Alpha=20.98u
+          Vk=123.7 Cgd=4.57p M=.4069 Pb=1 Fc=.5 Cgs=4.06p Kf=123E-18
+          Af=1)
*          National      pid=51          case=TO18
*          88-07-13 bam  BVmin=40
*$

```

```

.model J2N5457      NJF(Beta=1.125m Betatce=-.5 Rd=1 Rs=1 Lambda=2.3m Vto=-
1.372
+          Vtotc=-2.5m Is=181.3f Isr=1.747p N=1 Nr=2 Xti=3 Alpha=2.543u
+          Vk=152.2 Cgd=4p M=.3114 Pb=.5 Fc=.5 Cgs=4.627p Kf=10.45E-18
+          Af=1)
*          National      pid=55          case=TO92
*          88-08-03 rnm  BVmin=25
*$

```

\*-----  
\* Library of linear IC definitions

\* This is a reduced version of MicroSim's linear subcircuit library.  
\* You are welcome to make as many copies of it as you find convenient.  
\*  
\* The parameters in the opamp library were derived from the data sheets for  
\* each part. The macromodel used is similar to the one described in:  
\*  
\*     Macromodeling of Integrated Circuit Operational Amplifiers  
\*     by Graeme Boyle, Barry Cohn, Donald Pederson, and James Solomon  
\*     IEEE Journal of SoliE-State Circuits, Vol. SC-9, no. 6,     Dec. 1974  
\*  
\* Differences from the reference (above) occur in the output limiting stage  
\* which was modified to reduce internally generated currents associated with  
\* output voltage limiting, as well as short-circuit current limiting.  
\*  
\* The opamps are modelled at room temperature and do not track changes with  
\* temperature. This library file contains models for nominal, not worst case,  
\* devices.

```

*$
*-----
* connections: non-inverting input
*              | inverting input
*              || positive power supply
*              ||| negative power supply
*              |||| output
*              |||||

```

```

.subckt LM318 1 2 3 4 5
*

```

```

c1 11 12 2.887E-12
c2 6 7 20.00E-12
dc 5 53 dx
de 54 5 dx
dlp 90 91 dx
dln 92 90 dx
dp 4 3 dx
egnd 99 0 poly(2) (3,0) (4,0) 0 .5 .5
fb 7 99 poly(5) vb vc ve vlp vln 0 636.5E3 -600E3 600E3 600E3 -600E3
ga 6 0 11 12 12.57E-3
gcm 0 6 10 99 125.7E-9
iee 10 4 dc 1.400E-3
hlim 90 0 vlim 1K
q1 11 2 13 qx
q2 12 1 14 qx
r2 6 9 100.0E3
rc1 3 11 79.57
rc2 3 12 79.57
re1 13 10 42.61
re2 14 10 42.61
ree 10 99 142.8E3
ro1 8 5 50
ro2 7 99 25
rp 3 4 9.678E3
vb 9 0 dc 0
vc 3 53 dc 2
ve 54 4 dc 2
vlim 7 8 dc 0
vlp 91 0 dc 22
vln 0 92 dc 22
.model dx D(Is=800.0E-18 Rs=1)
.model qx NPN(Is=800.0E-18 Bf=4.667E3)
.ends
*$
*-----
* connections: non-inverting input
*           | inverting input
*           || positive power supply
*           ||| negative power supply
*           |||| output
*           |||||
.subckt LM324 1 2 3 4 5
*
c1 11 12 2.887E-12
c2 6 7 30.00E-12
dc 5 53 dx
de 54 5 dx
dlp 90 91 dx
dln 92 90 dx
dp 4 3 dx
egnd 99 0 poly(2) (3,0) (4,0) 0 .5 .5
fb 7 99 poly(5) vb vc ve vlp vln 0 21.22E6 -20E6 20E6 20E6 -20E6
ga 6 0 11 12 188.5E-6
gcm 0 6 10 99 59.61E-9

```

```

iee 3 10 dc 15.09E-6
hlim 90 0 vlim 1K
q1 11 2 13 qx
q2 12 1 14 qx
r2 6 9 100.0E3
rc1 4 11 5.305E3
rc2 4 12 5.305E3
re1 13 10 1.845E3
re2 14 10 1.845E3
ree 10 99 13.25E6
ro1 8 5 50
ro2 7 99 25
rp 3 4 9.082E3
vb 9 0 dc 0
vc 3 53 dc 1.500
ve 54 4 dc 0.65
vlim 7 8 dc 0
vlp 91 0 dc 40
vln 0 92 dc 40
.model dx D(Is=800.0E-18 Rs=1)
.model qx PNP(Is=800.0E-18 Bf=166.7)
.ends
*$
*-----
* connections: non-inverting input
*           | inverting input
*           || positive power supply
*           ||| negative power supply
*           |||| output
*           |||||
.subckt uA741 1 2 3 4 5
*
c1 11 12 8.661E-12
c2 6 7 30.00E-12
dc 5 53 dx
de 54 5 dx
dlp 90 91 dx
dln 92 90 dx
dp 4 3 dx
egnd 99 0 poly(2) (3,0) (4,0) 0 .5 .5
fb 7 99 poly(5) vb vc ve vlp vln 0 10.61E6 -10E6 10E6 10E6 -10E6
ga 6 0 11 12 188.5E-6
gcm 0 6 10 99 5.961E-9
iee 10 4 dc 15.16E-6
hlim 90 0 vlim 1K
q1 11 2 13 qx
q2 12 1 14 qx
r2 6 9 100.0E3
rc1 3 11 5.305E3
rc2 3 12 5.305E3
re1 13 10 1.836E3
re2 14 10 1.836E3
ree 10 99 13.19E6
ro1 8 5 50

```

```

ro2 7 99 100
rp 3 4 18.16E3
vb 9 0 dc 0
vc 3 53 dc 1
ve 54 4 dc 1
vlim 7 8 dc 0
vlp 91 0 dc 40
vln 0 92 dc 40
.model dx D(Is=800.0E-18 Rs=1)
.model qx NPN(Is=800.0E-18 Bf=93.75)
.ends
*$
*-----
* connections: non-inverting input
*           | inverting input
*           || positive power supply
*           ||| negative power supply
*           |||| output
*           |||||
.subckt LF411 1 2 3 4 5
*
c1 11 12 4.196E-12
c2 6 7 10.00E-12
css 10 99 1.333E-12
dc 5 53 dx
de 54 5 dx
dlp 90 91 dx
dln 92 90 dx
dp 4 3 dx
egnd 99 0 poly(2) (3,0) (4,0) 0 .5 .5
fb 7 99 poly(5) vb vc ve vlp vln 0 31.83E6 -30E6 30E6 30E6 -30E6
ga 6 0 11 12 251.4E-6
gcm 0 6 10 99 2.514E-9
iss 10 4 dc 170.0E-6
hlim 90 0 vlim 1K
j1 11 2 10 jx
j2 12 1 10 jx
r2 6 9 100.0E3
rd1 3 11 3.978E3
rd2 3 12 3.978E3
ro1 8 5 50
ro2 7 99 25
rp 3 4 15.00E3
rss 10 99 1.176E6
vb 9 0 dc 0
vc 3 53 dc 1.500
ve 54 4 dc 1.500
vlim 7 8 dc 0
vlp 91 0 dc 25
vln 0 92 dc 25
.model dx D(Is=800.0E-18 Rs=1m)
.model jx NJF(Is=12.50E-12 Beta=743.3E-6 Vto=-1)
.ends
*$

```

\*-----

\*\*\* Voltage comparators

\* The parameters in this comparator library were derived from data sheets for  
\* each parts. The macromodel used was developed by MicroSim Corporation, and  
\* is produced by the "Parts" option to PSpice.  
\*

\* Although we do not use it, another comparator macro model is described in:  
\*

\* An Integrated-Circuit Comparator Macromodel  
\* by Ian Getreu, Andreas Hadiwidjaja, and Johan Brinch  
\* IEEE Journal of Solid-State Circuits, Vol. SC-11, no. 6, Dec. 1976  
\*

\* This reference covers the considerations that go into duplicating the  
\* behavior of voltage comparators.  
\*

\* The comparators are modelled at room temperature. The macro model does not  
\* track changes with temperature. This library file contains models for  
\* nominal, not worst case, devices.  
\*

\*\$

\*-----

\* connections: non-inverting input  
\* | inverting input  
\* || positive power supply  
\* ||| negative power supply  
\* |||| open collector output  
\* ||||| output ground  
\* |||||

.subckt LM111 1 2 3 4 5 6

\*  
f1 9 3 v1 1  
iee 3 7 dc 100.0E-6  
vi1 21 1 dc .45  
vi2 22 2 dc .45  
q1 9 21 7 qin  
q2 8 22 7 qin  
q3 9 8 4 qmo  
q4 8 8 4 qmi  
.model qin PNP(Is=800.0E-18 Bf=833.3)  
.model qmi NPN(Is=800.0E-18 Bf=1002)  
.model qmo NPN(Is=800.0E-18 Bf=1000 Cjc=1E-15 Tr=118.8E-9)  
e1 10 6 9 4 1  
v1 10 11 dc 0  
q5 5 11 6 qoc  
.model qoc NPN(Is=800.0E-18 Bf=34.49E3 Cjc=1E-15 Tf=364.6E-12 Tr=79.34E-9)  
dp 4 3 dx  
rp 3 4 6.122E3  
.model dx D(Is=800.0E-18 Rs=1)  
\*

.ends

\*\$

\*-----

\* Library of magnetic core model parameters

\* This is a reduced version of MicroSim's magnetic core library.

\* You are welcome to make as many copies of it as you find convenient.

\* The parameters in this model library were derived from the data sheets for  
\* each core. The Jiles-Atherton magnetics model is described in:

\*

\* Theory of Ferromagnetic Hysteresis, by D C Jiles and D L Atherton,  
\* Journal of Magnetism and Magnetic Materials, vol 61 (1986) pp 48-60

\*

\* Model parameters for ferrite material (Ferroxcube 3C8) were obtained by  
\* trial simulations, using the B-H curves from the manufacturer's catalog.  
\* Then, the library was compiled from the data sheets for each core geometry.  
\* Notice that only the geometric values change once a material is  
\* characterized.

\* Example use: K2 L2 .99 K1409PL\_3C8

\* Notes:

\* 1) Using a K device (formerly only for mutual coupling) with a model  
\* reference changes the meaning of the L device: the inductance value  
\* becomes the number of turns for the winding.

\* 2) K devices can "get away" with specifying only one inductor, as in the  
\* example above, to simulate power inductors.

\* Example circuit file:

```
*+-----  
*|Demonstration of power inductor B-H curve  
*|  
*|* To view results with Probe (B-H curve):  
*|* 1) Add Trace for B(K1)  
*|* 2) set X-axis variable to H(K1)  
*|*  
*|* Probe x-axis unit is Oersted  
*|* Probe y-axis unit is Gauss  
*|*  
*|,tran .1 4  
*|igen0 0 1 sin(0 .1amp 1Hz 0) ; Generator: starts with 0.1 amp sinewave, then  
*|igen1 0 1 sin(0 .1amp 1Hz 1) ; +0.1 amps, starting at 1 second  
*|igen2 0 1 sin(0 .2amp 1Hz 2) ; +0.2 amps, starting at 2 seconds  
*|igen3 0 1 sin(0 .8amp 1Hz 3) ; +0.4 amps, starting at 3 seconds  
*|RL 1 0 1ohm ; generator source resistance  
*|L1 1 0 20 ; inductor with 20 turns  
*|K1 L1 .9999 K528T500_3C8 ; Ferroxcube torroid core  
*|,model K528T500_3C8 Core(LEVEL=2 ALPHA=0 MS=415.2K A=44.82 C=.4112  
K=25.74  
*|+ AREA=1.17 PATH=8.49)  
*|,options itl5=0  
*|,probe  
*|,end  
*+-----
```

```
*** Ferroxcube pot cores: 3C8 material
*$
.model K3019PL_3C8      Core(Level=2 Alpha=0 MS=415.2K A=44.82 C=.4112
K=25.74
+                      Area=1.38 Path=4.52)
```

```
*** Ferroxcube square cores: 3C8 material
*$
.model KRM8PL_3C8      Core(Level=2 Alpha=0 MS=415.2K A=44.82 C=.4112
K=25.74
+                      Area=.630 Path=3.84)
```

```
*** Ferroxcube toroid cores: 3C8 material
*$
.model K502T300_3C8     Core(Level=2 Alpha=0 MS=415.2K A=44.82 C=.4112
K=25.74
+                      Area=.371 Path=7.32)
.model K528T500_3C8     Core(Level=2 Alpha=0 MS=415.2K A=44.82 C=.4112
K=25.74
+                      Area=1.17 Path=8.49)
```

```
*$
```

```
*-----
* Library of MOSFET model parameters (for "power" MOSFET devices)
```

```
*
```

```
* This is a reduced version of MicroSim's power MOSFET model library.
```

```
* You are welcome to make as many copies of it as you find convenient.
```

```
*
```

```
* The parameters in this model library were derived from the data sheets for  
* each part. Each part was characterize using the Parts option.
```

```
* Device can also be characterized without Parts as follows:
```

```
* LEVEL          Set to 3 (short-channel device).
* TOX            Determined from gate ratings.
* L, LD, W, WD   Assume L=2u. Calculate from input capacitance.
* XJ, NSUB       Assume usual technology.
* IS, RD, RB     Determined from "source-drain diode forward voltage"  
*               specification or curve (Idr vs. Vsd).
* RS            Determine from Rds(on) specification.
* RDS           Calculated from Idss specification or curves.
* VTO, UO, THETA Determined from "output characteristics" curve family  
*               (Ids vs. Vds, stepped Vgs).
* ETA, VMAX, CBS Set for null effect.
* CBD, PB, MJ    Determined from "capacitance vs. Vds" curves.
* RG            Calculate from rise/fall time specification or curves.
* CGSO, CGDO    Determined from gate-charge, turn-on/off delay and  
*               rise time specifications.
```

```
*
```

```
* NOTE:          when specifying the instance of a device in your circuit file:
```

```
*
```

```
* BE SURE to have the source and bulk nodes connected together, as this  
* is the way the real device is constructed.
```

```
*
```

```
* DO NOT include values for L, W, AD, AS, PD, PS, NRD, or NDS.
```

```
* The PSpice default values for these parameters are taken into account  
* in the library model statements. Of course, you should NOT reset
```

\* the default values using the .OPTIONS statement, either.

\* Example use: M17 15 23 7 7 IRF150

\* The "power" MOSFET device models benefit from relatively complete specification of static and dynamic characteristics by their manufacturers. The following effects are modeled:

- \* - DC transfer curves in forward operation,
- \* - gate drive characteristics and switching delay,
- \* - "on" resistance,
- \* - reverse-mode "body-diode" operation.

\* The factors not modeled include:

- \* - maximum ratings (eg. high-voltage breakdown),
- \* - safe operating area (eg. power dissipation),
- \* - latch-up,
- \* - noise.

\* For high-current switching applications, we advise that you include series inductance elements, for the source and drain, in your circuit file. In doing so, voltage spikes due to di/dt will be modeled. According to the 1985 International Rectifier databook, the following case styles have lead inductance values of:

TO-204 (modified TO-3)	source = 12.5nH	drain = 5.0nH
TO-220	source = 7.5nH	drain = 3.5-4.5nH

\*\$

```
.model IRF150 NMOS(Level=3 Gamma=0 Delta=0 Eta=0 Theta=0 Kappa=0
Vmax=0 Xj=0
+ Tox=100n Uo=600 Phi=.6 Rs=1.624m Kp=20.53u W=.3 L=2u
Vto=2.831
+ Rd=1.031m Rds=444.4K Cbd=3.229n Pb=.8 Mj=.5 Fc=.5 Cgso=9.027n
+ Cgdo=1.679n Rg=13.89 Is=194E-18 N=1 Tt=288n)
* Int'l Rectifier pid=IRFC150 case=TO3
* 88-08-25 bam creation
```

\*\$

```
.model IRF9140 PMOS(Level=3 Gamma=0 Delta=0 Eta=0 Theta=0 Kappa=0
Vmax=0 Xj=0
+ Tox=100n Uo=300 Phi=.6 Rs=70.6m Kp=10.15u W=1.9 L=2u Vto=-
3.67
+ Rd=60.66m Rds=444.4K Cbd=2.141n Pb=.8 Mj=.5 Fc=.5 Cgso=877.2p
+ Cgdo=369.3p Rg=.811 Is=52.23E-18 N=2 Tt=140n)
* Int'l Rectifier pid=IRFC9140 case=TO3
* 88-08-25 bam creation
```

\*\$

\* Library of digital logic

\* Copyright 1992 by MicroSim Corporation

\* This is a reduced version of MicroSim's Digital components library.

\* You are welcome to make as many copies of it as you find convenient.

\*

*only one we have*



\* The parameters in this model library were derived from:  
 \*  
 \* The TTL Data Book, Texas Instruments, 1985  
 \* vol. 2  
 \*  
 \* Each device is modeled by a subcircuit. The interface pins of the  
 \* subcircuit have the same name as the pin labels in the data book. The  
 \* general order is inputs followed by outputs, but on the more complex  
 \* devices you will have to look at the subcircuit definition.  
 \* The word "BAR" is appended to inverted inputs or outputs.  
 \*  
 \* There are two optional power supply pins for each digital subcircuit.  
 \* You do not need to specify these if you are using a 5v supply with  
 \* analog and digital ground connected. If you use another power supply  
 \* configuration, then the pins should be connected to that supply.  
 \*  
 \* The timing characteristics from the data book are included in the models,  
 \* with all data sheet effects modeled, unless noted in this file.  
 \*  
 \* If a device contains multiple, independant, identical functions, only  
 \* one is contained in the subcircuit. (e.g. the 7400 contains four two-  
 \* input NAND gates, but there is only one in the 7400 subckt.)  
 \*  
 \* The subcircuit name is the part name. Only the 74 series (not the 54  
 \* series) is included in the library, except for a few parts which  
 \* are only made in the 54 series. (e.g. 54L00)

\*-----  
 \*\$  
 \* 7402 Quadruple 2-input Positive-Nor Gates  
 \*  
 \* The TTL Data Book, Vol 2, 1985, TI  
 \* tdn 06/23/89 Update interface and model names  
 \*  
 \*.subckt 7402 A B Y  
 + optional: DPWR=\$G\_DPWR DGND=\$G\_DGND  
 + params: MNTYMXDLY=0 IO\_LEVEL=0  
 U1 nor(2) DPWR DGND  
 + A B Y  
 + D\_02 IO\_STD MNTYMXDLY={MNTYMXDLY} IO\_LEVEL={IO\_LEVEL}  
 .ends

.model D\_02 ugate (  
 + tplhty=12ns tplhmx=22ns  
 + tphlty=8ns tphlhx=15ns  
 + )

\*-----  
 \*\$  
 \* 7404 Hex Inverters  
 \*  
 \* The TTL Data Book, Vol 2, 1985, TI  
 \* tdn 06/23/89 Update interface and model names

.subckt 7404 A Y  
 + optional: DPWR=\$G\_DPWR DGND=\$G\_DGND

```

+      params: MNTYMXDLY=0 IO_LEVEL=0
U1 inv DPWR DGND
+      A Y
+      D_04 IO_STD MNTYMXDLY={MNTYMXDLY} IO_LEVEL={IO_LEVEL}
.ends

.model D_04 ugate (
+      tplhty=12ns   tplhmx=22ns
+      tphlty=8ns   tphlmx=15ns
+      )
*-----
*$
* 7405 Hex Inverters with Open-Collector Outputs
*
* The TTL Data Book, Vol 2, 1985, TI
* tdn 06/23/89      Update interface and model names

.subckt 7405 A Y
+      optional: DPWR=$G_DPWR DGND=$G_DGND
+      params: MNTYMXDLY=0 IO_LEVEL=0
U1 inv DPWR DGND
+      A Y
+      D_05 IO_STD_OC MNTYMXDLY={MNTYMXDLY} IO_LEVEL={IO_LEVEL}
.ends

.model D_05 ugate (
+      tplhty=40ns   tplhmx=55ns
+      tphlty=8ns   tphlmx=15ns
+      )
*-----
*$
* 7414 Hex Schmitt-Trigger Inverters
*
* The TTL Data Book, Vol 2, 1985, TI
* tdn 06/23/89      Update interface and model names

.subckt 7414 A Y
+      optional: DPWR=$G_DPWR DGND=$G_DGND
+      params: MNTYMXDLY=0 IO_LEVEL=0
* Note: These devices are modeled as simple inverters
*       Hysteresis is modeled in the AtoD interface

U1 inv DPWR DGND
+      A Y
+      D_14 IO_STD_ST MNTYMXDLY={MNTYMXDLY} IO_LEVEL={IO_LEVEL}
.ends

.model D_14 ugate (
+      tplhty=15ns   tplhmx=22ns
+      tphlty=15ns   tphlmx=22ns
+      )
*-----
*$
* 7474 Dual D-Type Positive-Edge-Triggered Flip-Flops with Preset and Clear

```

```

*
* The TTL Data Book, Vol 2, 1985, TI
* tdn 06/28/89      Update interface and model names

.subckt 7474 1CLRBAR 1D 1CLK 1PREBAR 1Q 1QBAR
+   optional: DPWR=$G_DPWR DGND=$G_DGND
+   params: MNTYMXDLY=0 IO_LEVEL=0
UFF1 dff(1) DPWR DGND
+   1PREBAR 1CLRBAR 1CLK 1D 1Q 1QBAR
+   D_74 IO_STD MNTYMXDLY={MNTYMXDLY} IO_LEVEL={IO_LEVEL}
.ends

.model D_74 ueff (
+   twpclmn=30ns      twclkln=37ns
+   twclkhmn=30ns    tsudclkmn=20ns
+   thdclkmn=5ns     tppcqlhmx=25ns
+   tppcqlhmx=40ns   tpclkqlhty=14ns
+   tpclkqlhmx=25ns  tpclkqlhty=20ns
+   tpclkqlhmx=40ns
+   )
*-----
*$
* 74107 Dual J-K Flip-Flops with Clear
*
* The TTL Data Book, Vol 2, 1985, TI
* tdn 06/29/89      Update interface and model names

.subckt 74107 CLK CLRBAR J K Q QBAR
+   optional: DPWR=$G_DPWR DGND=$G_DGND
+   params: MNTYMXDLY=0 IO_LEVEL=0
UIBUF bufa(3) DPWR DGND
+   CLRBAR J K CLRBAR_BUF J_BUF K_BUF
+   D0_GATE IO_STD IO_LEVEL={IO_LEVEL}
U2BUF buf DPWR DGND
+   CLK CLK_BUF
+   D_107_4 IO_STD MNTYMXDLY={MNTYMXDLY} IO_LEVEL={IO_LEVEL}
U1 srff(1) DPWR DGND
+   $D_HI CLRBAR_BUF CLK_BUF W1 W2 Y YB
+   D_107_1 IO_STD MNTYMXDLY={MNTYMXDLY}
U2 srff(1) DPWR DGND
+   $D_HI CLRBAR_BUF CLKBAR Y YB QBUF QBAR_BUF
+   D_107_2 IO_STD MNTYMXDLY={MNTYMXDLY}
U3 inva(3) DPWR DGND
+   CLK_BUF J_BUF K_BUF CLKBAR JB KB
+   D0_GATE IO_STD
U4 ao(3,2) DPWR DGND
+   J_BUF K_BUF QBAR_BUF D J_BUF KB $D_HI W1
+   D_107_3 IO_STD MNTYMXDLY={MNTYMXDLY}
U5 ao(3,2) DPWR DGND
+   J_BUF K_BUF QBUFD JB K_BUF $D_HI W2
+   D_107_3 IO_STD MNTYMXDLY={MNTYMXDLY}
UBUF bufa(4) DPWR DGND
+   QBUF QBAR_BUF QBUFD QBAR_BUF Q QBAR QBUFD QBAR_BUF
+   D_107_3 IO_STD MNTYMXDLY={MNTYMXDLY} IO_LEVEL={IO_LEVEL}

```

```

.ends

.model D_107_1 ugff (
+   twghmx=19ns           twghty=19ns
+   twpclmx=47ns        twpclty=47ns
+   )
.model D_107_2 ugff (
+   tppcqlhty=10ns       tppcqlhmx=19ns
+   tppcqlhty=19ns       tppcqlhmx=34ns
+   tpgqhlty=10ns        tpgqhlmx=19ns
+   tpgqhlty=19ns        tpgqhlmx=34ns
+   twghmx=20ns          twghty=20ns
+   twpclmx=47ns        twpclty=47ns
+   )
.model D_107_3 ugate (
+   tplhty=6ns           tplhmx=6ns
+   tphlty=6ns           tphlmx=6ns
+   )
.model D_107_4 ugate (
+   tplhmn=6ns           tplhmx=6ns
+   )
*-----
*$
* 74393 Dual 4-bit Binary Counter with Individual Clocks
*
* The TTL Data Book, Vol 2, 1985, TI
* atl 7/18/89 Update interface and model names

.subckt 74393 A CLR QA QB QC QD
+   optional: DPWR=$G_DPWR DGND=$G_DGND
+   params: MNTYMXDLY=0 IO_LEVEL=0
UINV inv DPWR DGND
+   CLR CLRBAR
+   D0_GATE IO_STD IO_LEVEL={IO_LEVEL}
U1 jkff(1) DPWR DGND
+   $D_HI CLRBAR A $D_HI $D_HI QA_BUF $D_NC
+   D_393_1 IO_STD MNTYMXDLY={MNTYMXDLY} IO_LEVEL={IO_LEVEL}
U2 jkff(1) DPWR DGND
+   $D_HI CLRBAR QA_BUF $D_HI $D_HI QB_BUF $D_NC
+   D_393_2 IO_STD MNTYMXDLY={MNTYMXDLY}
U3 jkff(1) DPWR DGND
+   $D_HI CLRBAR QB_BUF $D_HI $D_HI QC_BUF $D_NC
+   D_393_2 IO_STD MNTYMXDLY={MNTYMXDLY}
U4 jkff(1) DPWR DGND
+   $D_HI CLRBAR QC_BUF $D_HI $D_HI QD_BUF $D_NC
+   D_393_3 IO_STD MNTYMXDLY={MNTYMXDLY}
UBUFF bufa(4) DPWR DGND
+   QA_BUF QB_BUF QC_BUF QD_BUF QA QB QC QD
+   D_393_4 IO_STD MNTYMXDLY={MNTYMXDLY} IO_LEVEL={IO_LEVEL}
.ends

.model D_393_1 ueff (
+   tppcqlhty=18ns       tppcqlhmx=33ns
+   tpclkqlhty=6ns       tpclkqlhmx=14ns

```

```

+      tpclkqhlty=7ns      tpclkqhlmx=14ns
+      twclkhmn=20ns      twclklmn=20ns
+      twpclmn=20ns      tsudclkmn=25ns
+      )
.model D_393_2 ueff ()
.model D_393_3 ueff (
+      tpclkqhlty=27ns      tpclkqhlmx=40ns
+      tpclkqhlty=27ns      tpclkqhlmx=40ns
+      )
.model D_393_4 ugate (
+      tphlty=6ns      tphlmx=6ns
+      tplhly=6ns      tplhmx=6ns
+      )

```

\*\$

#### \* AtoD and DtoA Subcircuits

\* -----

\* The subcircuits in this library are used to convert analog signals  
\* into digital signals (AtoD) and digital signals into analog signals  
\* (DtoA). The PSpice Digital Simulation Option creates "X" devices which  
\* reference these subcircuits whenever it needs to convert a digital or  
\* analog signal. The user usually will not need to use these subcircuits  
\* directly. However, if you need to add new AtoD or DtoA subcircuits, the  
\* interface nodes must be in the following order, and have the following  
\* parameters:

```

* AtoD: .subckt <name> <analog-node> <dig-node> <dig-pwr> <dig-gnd>
*      +      params: CAPACITANCE=0

```

```

* DtoA: .subckt <name> <dig-node> <analog-node> <dig-pwr> <dig-gnd>
*      +      params: DRVL=0 DRVH=0 CAPACITANCE=0

```

#### \* I/O Models

\* -----

\* I/O models specify the names of the AtoD and DtoA subcircuits PSpice must  
\* use to convert analog signals to digital signals or vice versa. (I/O models  
\* also describe driving and loading characteristics.) Up to four of each  
\* AtoD and DtoA subcircuit names may be specified in an I/O model, using  
\* parameters AtoD1 through AtoD4, and DtoA1 through DtoA4. The subcircuit  
\* which PSpice actually uses depends on the value of the IO\_LEVEL parameter  
\* in a subcircuit reference.

\* As implemented in this library, the levels have the following definitions:

#### \* IO\_LEVEL Definition

\* -----

- \* 1 Basic (simple) model with X, R, and F between VIL max and VIH min (AtoD)
- \* 2 Basic (simple) model without intermediate X value
- \* 3 Elaborate model with X between VIL max and VIH min (AtoD)
- \* 4 Elaborate model without intermediate X, R, and F value

\* The Elaborate model has a more accurate I-V curve, including clamping  
\* diodes, but since it has more devices, it can take longer to simulate  
\* when it is used.

\*

\* For example, to specify the basic interface without an intermediate  
 \* X value, you would use:  
 \*  
 \* X1 in out 74LS04 PARAMS: IO\_LEVEL=2  
 \*  
 \* If the IO\_LEVEL is not specified for a device, the default IO\_LEVEL is used.  
 \* The default level is controled by the .OPTION parameter DIGIOLVL, which  
 \* defaults to 1.  
 \*

\*\$

\*-----

\* Digital Power Supply

\*-----

\* PSpice automatically creates one instance of this subcircuit if any  
 \* AtoD or DtoA interfaces are created. PSpice always uses node 0 as the  
 \* required analog reference node "GND". The digital power and ground  
 \* nodes default to global nodes named \$G\_DPWR and \$G\_DGND, which are  
 \* used throughout the digital libraries. The default output is 5.0v.  
 \*

\* To create your own power supply, simply create an instance of this  
 \* subcircuit, using your own digital power and ground node names, and  
 \* the desired voltage. For example:

\* XMYPOWER 0 MY\_PWR MY\_GND DIGIFPWR params: VOLTAGE=3.5V  
 \*

```
.subckt DIGIFPWR AGND
+   optional: DPWR=$G_DPWR DGND=$G_DGND
+   params:  VOLTAGE=5.0v REFERENCE=0v
*
```

```
VDPWR DPWR DGND {VOLTAGE}
R1  DPWR AGND 1MEG
VDGND DGND REF {REFERENCE}
R2  REF AGND 1E-6
R3  DGND AGND 1MEG
.ends
```

\*\$

\*-----

\* Stimulus Device Models and Subcircuits

\*-----

\*-----

\* Stimulus I/O Models

```
.model IO_STM uiio (
+   drvh=0      drv1=0
+   DtoA1="DtoA_STM" DtoA2="DtoA_STM"
+   DtoA3="DtoA_STM" DtoA4="DtoA_STM"
+   )
.model IO_STM_OC uiio (
+   drvh=1MEG  drv1=0
```

```

+   DtoA1="DtoA_STM_OC"   DtoA2="DtoA_STM_OC"
+   DtoA3="DtoA_STM_OC"   DtoA4="DtoA_STM_OC"
+   )

```

```

*-----

```

```

* Stimulus DtoA Subcircuit

```

```

.subckt DtoA_STM D A DPWR DGND
+   params: DRVL=0 DRVH=0 CAPACITANCE=0
*
N1 A DGND DPWR DINSTM DGTLNET=D IO_STM
C1 A 0 {CAPACITANCE+0.1pF}
.ends

```

```

*-----

```

```

* Stimulus Open Collector DtoA Subcircuit

```

```

.subckt DtoA_STM_OC D A DPWR DGND
+   params: DRVL=0 DRVH=0 CAPACITANCE=0
*
N1 A DGND DPWR DINSTM_OC DGTLNET=D IO_STM_OC
C1 A 0 {CAPACITANCE+0.1pF}
.ends

```

```

*-----

```

```

* Stimulus Digital Input/Output Models

```

```

*
```

```

* We use 1/2 ohm and a 500ps transition time, on the assumption that
* this will be a "strong" signal source with a "fast" switching time
* in most systems which use this library. Change the tsw's and/or the
* rlow and rhi values if these don't work for your system.
*
```

```

.model DINSTM dinput (
+   s0name="0"   s0tsw=0.5ns   s0rlo=.5       s0rhi=1k
+   s1name="1"   s1tsw=0.5ns   s1rlo=1k       s1rhi=.5
+   s2name="X"   s2tsw=0.5ns   s2rlo=0.429   s2rhi=1.16 ; .313ohm, 1.35v
+   s3name="R"   s3tsw=0.5ns   s3rlo=0.429   s3rhi=1.16 ; .313ohm, 1.35v
+   s4name="F"   s4tsw=0.5ns   s4rlo=0.429   s4rhi=1.16 ; .313ohm, 1.35v
+   s5name="Z"   s5tsw=0.5ns   s5rlo=1MEG    s5rhi=1MEG
+   )

```

```

.model DINSTM_OC dinput (
+   s0name="0"   s0tsw=0.5ns   s0rlo=.5       s0rhi=1k
+   s1name="1"   s1tsw=0.5ns   s1rlo=1MEG     s1rhi=1MEG
+   s2name="X"   s2tsw=0.5ns   s2rlo=0.429   s2rhi=1.16 ; .313ohm, 1.35v
+   s3name="R"   s3tsw=0.5ns   s3rlo=0.429   s3rhi=1.16 ; .313ohm, 1.35v
+   s4name="F"   s4tsw=0.5ns   s4rlo=0.429   s4rhi=1.16 ; .313ohm, 1.35v
+   s5name="Z"   s5tsw=0.5ns   s5rlo=1MEG    s5rhi=1MEG
+   )

```

```

*-----

```

```

* Zero-Delay Models

```

```

*-----

```

\*-----

\* Zero-Delay Gate Model

.model D0\_GATE ugate ()

\*-----

\* Zero-Delay Tristate Gate Model

.model D0\_TGATE utgate ()

\*-----

\* Zero-Delay Edge-Triggered Flip-Flop Model

.model D0\_EFF ueff ()

\*-----

\* Zero-Delay Gated Flip-Flop Model

.model D0\_GFF ugff ()

\*\*\*\*\*

\*\*\*\*\*

\* 74/54 Family (standard TTL)

\*\*\*\*\*

\*\*\*\*\*

\*-----

\* 7400 I/O Models

.model IO\_STD uio (

+ drvh=96.4 drvl=104  
+ AtoD1="AtoD\_STD" AtoD2="AtoD\_STD\_NX"  
+ AtoD3="AtoD\_STD\_E" AtoD4="AtoD\_STD\_NXE"  
+ DtoA1="DtoA\_STD" DtoA2="DtoA\_STD"  
+ DtoA3="DtoA\_STD" DtoA4="DtoA\_STD"  
+ )

.model IO\_STD\_ST uio (

+ drvh=96.4 drvl=104  
+ AtoD1="AtoD\_STD\_ST" AtoD2="AtoD\_STD\_ST"  
+ AtoD3="AtoD\_STD\_ST\_E" AtoD4="AtoD\_STD\_ST\_E"  
+ DtoA1="DtoA\_STD" DtoA2="DtoA\_STD"  
+ DtoA3="DtoA\_STD" DtoA4="DtoA\_STD"  
+ )

.model IO\_STD\_OC uio (

+ drvh=1MEG drvl=104  
+ AtoD1="AtoD\_STD" AtoD2="AtoD\_STD\_NX"  
+ AtoD3="AtoD\_STD\_E" AtoD4="AtoD\_STD\_NXE"  
+ DtoA1="DtoA\_STD\_OC" DtoA2="DtoA\_STD\_OC"  
+ DtoA3="DtoA\_STD\_OC" DtoA4="DtoA\_STD\_OC"  
+ )

\*-----

\* 7400 Standard AtoD Subcircuits



\* Simple Models:

```
.subckt AtoD_STD A D DPWR DGND
+   params: CAPACITANCE=0
*
O0 A DGND DO74 DGTLNET=D IO_STD
C1 A 0 {CAPACITANCE+0.1pF}
.ends
```

```
.subckt AtoD_STD_NX A D DPWR DGND
+   params: CAPACITANCE=0
*
O0 A DGND DO74_NX DGTLNET=D IO_STD
C1 A 0 {CAPACITANCE+0.1pF}
.ends
```

\* Elaborate Models:

```
.subckt AtoD_STD_E A D DPWR DGND
+   params: CAPACITANCE=0
*
O0 A DGND DO74 DGTLNET=D IO_STD
C1 A 0 {CAPACITANCE+0.1pF}
D0  DGND      a    D74CLMP
D1  1         2    D74
D2  2         DGND D74
R1  DPWR      3    4k
Q1  1 3 A 0    Q74 ; substrait should be DGND
.ends
```

```
.subckt AtoD_STD_NXE A D DPWR DGND
+   params: CAPACITANCE=0
*
O0 A DGND DO74_NX DGTLNET=D IO_STD
C1 A 0 {CAPACITANCE+0.1pF}
D0  DGND      a    D74CLMP
D1  1         2    D74
D2  2         DGND D74
R1  DPWR      3    4k
Q1  1 3 A 0    Q74 ; substrait should be DGND
.ends
```

\*-----  
\* 7400 Schmidt trigger AtoD Subcircuits

\* Simple Model:

```
.subckt AtoD_STD_ST A D DPWR DGND
+   params: CAPACITANCE=0
*
O0 A DGND DO74_ST DGTLNET=D IO_STD
C1 A 0 {CAPACITANCE+0.1pF}
.ends
```

\* Elaborate Model:

```
.subckt AtoD_STD_ST_E A D DPWR DGND
+   params: CAPACITANCE=0
*
O0 A DGND DO74_ST DGTLNET=D IO_STD
C1 A 0 {CAPACITANCE+0.1pF}
D0  DGND      a      D74CLMP
D1  1         2      D74
D2  2         DGND   D74
R1  DPWR      3      4k
Q1  1         3      A   0   Q74
.ends
```

\*-----  
\* 7400 standard DtoA Subcircuit

```
.subckt DtoA_STD D A DPWR DGND
+   params: DRVL=0 DRVH=0 CAPACITANCE=0
*
N1 A DGND DPWR DIN74 DGTLNET=D IO_STD
C1 A 0 {CAPACITANCE+0.1pF}
.ends
```

\*-----  
\* 7400 open collector DtoA Subcircuit

```
.subckt DtoA_STD_OC D A DPWR DGND
+   params: DRVL=0 DRVH=0 CAPACITANCE=0
*
N1 A DGND DPWR DIN74_OC DGTLNET=D IO_STD_OC
C1 A 0 {CAPACITANCE+0.1pF}
.ends
```

\*-----  
\* 7400 Digital Input/Output Models

```
.model DIN74 dinput (
+   s0name="0"  s0tsw=3.5ns  s0rlo=7.13  s0rhi=389 ; 7ohm, 0.09v
+   s1name="1"  s1tsw=5.5ns  s1rlo=467   s1rhi=200 ; 140ohm, 3.5v
+   s2name="X"  s2tsw=3.5ns  s2rlo=42.9  s2rhi=116 ; 31.3ohm, 1.35v
+   s3name="R"  s3tsw=3.5ns  s3rlo=42.9  s3rhi=116 ; 31.3ohm, 1.35v
+   s4name="F"  s4tsw=3.5ns  s4rlo=42.9  s4rhi=116 ; 31.3ohm, 1.35v
+   s5name="Z"  s5tsw=3.5ns  s5rlo=200K  s5rhi=200K
+ )
.model DIN74_OC dinput (
+   s0name="0"  s0tsw=3.5ns  s0rlo=7.13  s0rhi=389 ; 7ohm, 0.09v
+   s1name="1"  s1tsw=5.5ns  s1rlo=200K  s1rhi=200K
+   s2name="X"  s2tsw=3.5ns  s2rlo=42.9  s2rhi=116 ; 31.3ohm, 1.35v
+   s3name="R"  s3tsw=3.5ns  s3rlo=42.9  s3rhi=116 ; 31.3ohm, 1.35v
+   s4name="F"  s4tsw=3.5ns  s4rlo=42.9  s4rhi=116 ; 31.3ohm, 1.35v
+   s5name="Z"  s5tsw=5.5ns  s5rlo=200K  s5rhi=200K
+ )
```

```

.model DO74 doutput (
+   s0name="X"  s0vlo=0.8   s0vhi=2.0
+   s1name="0"  s1vlo=-1.5  s1vhi=0.8
+   s2name="R"  s2vlo=0.8   s2vhi=1.4
+   s3name="R"  s3vlo=1.3   s3vhi=2.0
+   s4name="X"  s4vlo=0.8   s4vhi=2.0
+   s5name="1"  s5vlo=2.0   s5vhi=7.0
+   s6name="F"  s6vlo=1.3   s6vhi=2.0
+   s7name="F"  s7vlo=0.8   s7vhi=1.4
+ )
.model DO74_NX doutput (
+   s0name="0"  s0vlo=-1.5  s0vhi=1.35
+   s2name="1"  s2vlo=1.35  s2vhi=7.0
+ )
.model DO74_ST doutput (
+   s0name="0"  s0vlo=-1.5  s0vhi=1.7
+   s1name="1"  s1vlo=0.9   s1vhi=7.0
+ )

.model D74 d (
+   is=1e-16    rs=25   cjo=2pf
+ )
.model D74CLMP d (
+   is=1e-15    rs=2    cjo=2pf
+ )
.model Q74 npn (
+   ise=1e-16    isc=4e-16
+   bf=49   br=.03
+   cje=1pf   cjc=.5pf
+   cjs=3pf   vje=0.9v
+   vjc=0.8v  vjs=0.7v
+   mje=0.5   mjc=0.33
+   mjs=0.33  tf=0.2ns
+   tr=10ns   rb=50
+   rc=20
+ )
*$
*-----
* Library of optocoupler models

* Copyright 1992 by MicroSim Corporation
* This is a reduced version of MicroSim's Opto-coupler components library.
* You are welcome to make as many copies of it as you find convenient.

* The parameters in this model library were derived from the data sheets for
* each part.
*$
*.model 4N25
* 6-pin DIP: pin #1 #2 #4 #5 #6
*   | | | | |
.subckt A4N25 pin1 pin2 pin4 pin5 pin6 params: rel_CTR=1
*   Motorola pid=4N25
*   88-01-04 pwt
*   88-01-18 pwt rework Cje approximation

```

- \* The data sheet used for this model is from Motorola: it was the most
- \* complete for DC and switching parameters, and it was easy to find the
- \* component IR-LED and phototransistor as separate devices for further
- \* specifications.

```

d_MainLED pin1 pin2 MainLED
d_PhotoLED pin1 1 PhotoLED .001
v_PhotoLED 1 pin2 0

f_TempComp 0 2 v_PhotoLED 1
r_TempComp 2 0 TempComp {rel_CTR}

g_BaseSrc 5 6 2 0 .9
q_PhotoBJT 5 6 4 PhotoBJT
r_C 5 pin5 .1
r_B 6 pin6 .1
r_E 4 pin4 .1

```

- \* Since active devices dominate pin-to-pin capacitance on each "side" of the
- \* optocoupler, isolation is modeled by identical capacitances and resistances
- \* linked to a common point; this gives isolation of .5pF and 1E+11 ohms

```

c_1 pin1 7 .4p
r_1 pin1 7 .12T
c_2 pin2 7 .4p
r_2 pin2 7 .12T
c_4 pin4 7 .4p
r_4 pin4 7 .12T
c_5 pin5 7 .4p
r_5 pin5 7 .12T
c_6 pin6 7 .4p
r_6 pin6 7 .12T

```

- \* Similar to Motorola MLED15.

```

.model MainLED D(Is=1.1p Rs=.66 Ikf=30m N=1.9 Xti=3 Cjo=40p M=.34 Vj=.75
+ Isr=30n Nr=3.8 Bv=6 Ibv=100u Tt=.5u)

```

- \* Models photon generation: same as MainLED except no AC effects, no breakdown.

```

.model PhotoLED D(Is=1.1p Rs=.66 Ikf=30m N=1.9 Xti=3 Cjo=0 M=.34 Vj=.75
+ Isr=30n Nr=3.8 Bv=0 Tt=0)

```

- \* Temperature compensation for system: 1.38x @ -55'C, .54x @ +100'C, all @ 10mA

- \* Note: the photo BJT has its own temperature corrections, which must be kept

- \* as the transistor is electrically available.

```

.model TempComp RES(R=1 Tc1=-11.27m Tc2=43.46u)

```

- \* Similar to Motorola MDR3050; Hfe=325 @ Ic=500uA, Vce=5V

- \* Use beta variation (w/Parts) to model change in current-transfer ratio (CTR).

- \* Hand adjust reverse beta (Br) to match saturation characteristics.

- \* Set Isc to model dark current.

- \* Hand adjust Cjc to match fall time @ Ic=10mA (which yields rise time, too).

- \* Hand adjust reverse transit-time (Tr) to match storage time @ Ic=10mA.

- \* Delay time set by LED I-V and C-V characteristics; set Cje to 25% of Cjc,

- \* inspection of phototransistor chip layouts show the emitter area is 20%-25%

- \* that of the collector area. The same layouts show that base resistance is
- \* made negligible by design; also, the operating currents are small.
- \* Hand adjust forward transit-time (Tf) to match MDR3050 pulse data. Check
- \* against 4N25 frequency response (Fig 11, 12).

```
.model PhotoBJT NPN(Is=10f Xti=3 Vaf=60
+          Bf=400 Ne=3.75 Ise=580p Ikf=.26 Xtb=1.5
+          Br=.04 Nc=2   Isc=3.5n
+          Cjc=10p  Mjc=.3333 Vjc=.75 Tr=88u
+          Cje=2.5p Mje=.3333 Vje=.75 Tf=1.5n)
```

.ends

\*\$

\*.model 4N25A

\* 6-pin DIP: pin #1 #2 #4 #5 #6

\* | | | | |

.subckt A4N25A pin1 pin2 pin4 pin5 pin6

\* 88-01-05 pwt

\* Same as 4N25 (UL recognized).

x1 pin1 pin2 pin4 pin5 pin6 A4N25

.ends

\*\$

\*-----

\* Library of Thyristor (SCR and Triac) models

\* Copyright 1992 by MicroSim Corporation

\* This is a reduced version of MicroSim's Thyristor components library.

\* You are welcome to make as many copies of it as you find convenient.

\* Library of SCR models

\* NOTE: This library requires the "Analog Behavioral Modeling"

\* option available with PSpice. A model developed without

\* Behavioral Modeling was found to be very slow and not

\* very robust.

\* This macromodel uses a controlled switch as the basic SCR

\* structure. In all cases, the designer should use

\* the manufacturer's data book for actual part selection.

\* The required parameters were derived from data sheet (Motorola)

\* information on each part. When available, only "typical"

\* parameters are used (except for Idrm which is always

\* a "max" value). If a "typical" parameter is not available,

\* a "min" or "max" value may be used in which case a comment is

\* made in the library.

\* The SCRs are modeled at room temperature and do not track

\* changes with temperature. Note that Vdrm is specified by the

\* manufacturer as valid over a temperature range. Also, in

\* nearly all cases, dVdt and Toff are specified by the

\* manufacturer at approximately 100 degrees C. This results in a

\* model which is somewhat "conservative" for a room temperature

\* model.

\* The parameter dVdt (when available from the date sheet) is used

\* to model the Critical Rate of Rise of Off-State Voltage. If  
 \* not specified, dVdt is defaulted to 1000 V/microsecond.  
 \* A side effect of this model is that the turn-on current, Ion,  
 \* is determined by  $V_{tm}/(I_h * V_{drm})$ .  $V_{tm}$  is also used as the  
 \* holding voltage.

\*\$

.SUBCKT Scr anode gate cathode PARAMS:

+ Vdrm=400v Vrrm=400v Idrm=10u  
 + Ih=6ma dVdt=5e7  
 + Igt=5ma Vgt=0.7v  
 + Vtm=1.7v Itm=24  
 + Ton=1u Toff=15u

\* Where:

\* Vdrm => Forward breakover voltage  
 \* Vrrm => Reverse breakdown voltage  
 \* Idrm => Peak blocking current  
 \* Ih => Holding current  
 \* dVdt => Critical value for dV/dt triggering  
 \* Igt => Gate trigger current  
 \* Vgt => Gate trigger voltage  
 \* Vtm => On-state voltage  
 \* Itm => On-state current  
 \* Ton => Turn-on time  
 \* Toff => Turn-off time

\* Main conduction path

Scr anode anode0 control 0 Vswitch ; controlled switch  
 Dak1 anode0 anode2 Dakfwd OFF ; SCR is initially off  
 Dka cathode anode0 Dkarev OFF  
 VIak anode2 cathode ; current sensor

\* dVdt Turn-on

Emon dvdt0 0 TABLE {v(anode,cathode)} (0 0) (2000 2000)  
 CdVdt dvdt0 dvdt1 100pfd ; displacement current  
 Rdlay dvdt1 dvdt2 1k  
 VdVdt dvdt2 cathode DC 0.0  
 EdVdt condvdt 0 TABLE {i(vdVdt)-100p\*dVdt} (0 0) (.1m 10)  
 RdVdt condvdt 0 1meg

\* Gate

Rseries gate gate1 {(Vgt-0.65)/Igt}  
 Rshunt gate1 gate2 {0.65/Igt}  
 Dgkf gate1 gate2 Dgk  
 VIgf gate2 cathode ; current sensor

\* Gate Turn-on

Egate1 gate4 0 TABLE {i(Vigf)-0.95\*Igt} (0 0) (1m 10)  
 Rgate1 gate4 0 1meg  
 Egon1 congate 0 TABLE {v(gate4)\*v(anode,cathode)} (0 0) (10 10)  
 Rgon1 congate 0 1meg

\* Main Turn-on

EItot Itot 0 TABLE {i(VIak)+5E-5\*i(VIgf)/Igt} (0 0) (2000 2000)

```

RItot Itot 0 1meg
Eprod prod 0 TABLE {v(anode,cathode)*v(Itot)} (0 0) (1 1)
Rprod prod 0 1meg
Elin conmain 0 TABLE
+ {10*(v(prod) - (Vtm*Ih))/(Vtm*Ih)} (0 0) (2 10)
Rlin conmain 0 1meg

* Turn-on/Turn-off control
Eonoff contot 0 TABLE
+ {v(congate)+v(conmain)+v(condvdt)} (0 0) (10 10)

* Turn-on/Turn-off delays
Rton contot dlay1 825
Dton dlay1 control Delay
Rtoff contot dlay2 {290*Toff/Ton}
Dtoff control dlay2 Delay
Cton control 0 {Ton/454}

* Reverse breakdown
Dbreak anode break1 Dbreak
Dbreak2 cathode break1 Dseries

* Controlled switch model
.MODEL Vswitch vswitch
+ (Ron = {(Vtm-0.7)/Itm}, Roff = {Vdrm*Vdrm/(Vtm*Ih)},
+ Von = 5.0, Voff = 1.5)

* Diodes
.MODEL Dgk D (Is=1E-16 Cjo=50pf Rs=5)
.MODEL Dseries D (Is=1E-14)
.MODEL Delay D (Is=1E-12 Cjo=5pf Rs=0.01)
.MODEL Dkarev D (Is=1E-10 Cjo=5pf Rs=0.01)
.MODEL Dakfwd D (Is=4E-11 Cjo=5pf)
.MODEL Dbreak D (Ibv=1E-7 Bv={1.1*Vrrm} Cjo=5pf Rs=0.5)

* Allow the gate to float if required
Rfloat gate cathode 1e10

.ENDS
*$
.SUBCKT 2N1595 anode gate cathode
* "Typical" parameters
X1 anode gate cathode Scr PARAMS:
+ Vdrm=50v Vrrm=50v Ih=5ma Vtm=1.1v Itm=1
+ dVdt=1e9 Igt=2ma Vgt=.7v Ton=0.8u Toff=10u
+ Idm=10u
* 90-5-18 Motorola DL137, Rev 2, 3/89
.ENDS
*$
* Library of Triac models

* NOTE: This library requires the "Analog Behavioral Modeling"
* option available with PSpice.

```

- \* This macromodel uses two controlled switches as the basic triac structure. The model was developed to provide firing in all four quadrants. It should be noted, however, that the library contains parts which the manufacturer has guaranteed will fire in 4 quadrants, 3 quadrants or 2 quadrants. Therefore, the designer should always use the manufacturer's data book for part selection.

- \* The required parameters were derived from data sheet (Motorola) information on each part. When available, only "typical" parameters are used (except for  $I_{drm}$  which is always a "max" value). If a "typical" parameter is not available, a "min" or "max" value may be used in which case a comment is made in the library.

- \* The triacs are modeled at room temperature and do not track changes with temperature. Note that  $V_{drm}$  is specified by the manufacturer as valid over a temperature range. Also, in nearly all cases,  $dV/dt$  is specified by the manufacturer at approximately 100 degrees C. This results in a model which is somewhat "conservative" for a room temperature model.

- \* The parameter  $dV/dt$  (when available from the data sheet) is used to model the Critical Rate of Rise of Off-State Voltage. If not specified,  $dV/dt$  is defaulted to 1000 V/microsecond. The Critical Rate of Rise of Commutation Voltage is not modeled. It is generally good practice to use an RC snubber network across the triac to limit the commutating  $dV/dt$  to a value below the maximum allowable rating (see manufacturer's data sheet and application notes). Also, note that the turn-off time is assumed to be zero.

\*\$

.SUBCKT Triac MT2 gate MT1 PARAMS:

```
+ Vdrm=400v  Idm=10u
+ Ih=6ma     dVdt=50e6
+ Igt=20ma   Vgt=0.9v
+ Vtm=1.3v   Itm=17
+ Ton=1.5u
```

\* Where:

- \*  $V_{drm}$  => Forward breakover voltage
- \*  $I_{drm}$  => Peak blocking current
- \*  $I_h$  => Holding current [MT2(+)]
- \*  $dV/dt$  => Critical value for  $dV/dt$  triggering
- \*  $I_{gt}$  => Gate trigger current [MT2(+),G(-)]
- \*  $V_{gt}$  => Gate trigger voltage [MT2(+),G(-)]
- \*  $V_{tm}$  => On-state voltage
- \*  $I_{tm}$  => On-state current
- \*  $T_{on}$  => Turn-on time

\* Main conduction path

```
Striac MT2 MT20 cntrol 0 Vswitch ; controlled switch
Dak1 MT20 MT22 Dak OFF ; triac is initially off
VIak MT22 MT1 ; current sensor
```



Striacr MT2 MT23 cntrolr 0 Vswitch ; controlled switch  
 Dka1 MT21 MT23 Dak OFF ; triac is initially off  
 Vika MT1 MT21 ; reverse current sense

\* dVdt Turn-on

Emon dvdt0 0 TABLE {ABS(V(MT2,MT1))} (0 0) (2000 2000)  
 CdVdt dvdt0 dvdt1 100pfd ; displacement current  
 Rdlay dvdt1 dvdt2 1k  
 VdVdt dvdt2 MT1 DC 0.0  
 EdVdt condvdt 0 TABLE {i(vdVdt)-100p\*dVdt} (0 0) (.1m 10)  
 RdVdt condvdt 0 1meg

\* Gate

Rseries gate gate1 {(Vgt-0.65)/Igt}  
 Rshunt gate1 gate2 {0.65/Igt}  
 Dgkf gate1 gate2 Dgk  
 Dgkr gate2 gate1 Dgk  
 VIgf gate2 MT1 DC 0.0 ; current sensor

\* Gate Turn-on

Egate congate 0 TABLE {(ABS(i(VIgf))-0.95\*Igt)} (0 0) (1m 10)  
 Rgate congate 0 1meg

\* Holding current, holding voltage (Quadrant I)

Emain1 main1 0 TABLE {i(VIak)-Ih+5e-3\*i(VIgf)/Igt} (0 0) (.1m 1)  
 Rmain1 main1 0 1meg  
 Emain2 main2 0 TABLE {v(MT2,MT1)-(Ih\*Vtm/Itm)} (0 0) (.1m 1)  
 Rmain2 main2 0 1meg  
 Emain3 cnhold 0 TABLE {v(main1,0)\*v(main2,0)} (0 0) (1 10)  
 Rmain3 cnhold 0 1meg

\* Holding current, holding voltage (Quadrant III)

Emain1r main1r 0 TABLE {i(VIka)-Ih-5e-3\*i(VIgf)/Igt} (0 0) (.1m 1)  
 Rmain1r main1r 0 1meg  
 Emain2r main2r 0 TABLE {v(MT1,MT2)-(Ih\*Vtm/Itm)} (0 0) (.1m 1)  
 Rmain2r main2r 0 1meg  
 Emain3r cnholdr 0 TABLE {v(main1r,0)\*v(main2r,0)} (0 0) (1 10)  
 Rmain3r cnholdr 0 1meg

\* Main

Emain4 main4 0 table {(1.0-ABS(i(VIgf))/Igt)} (0 0) (1 1)  
 Rmain4 main4 0 1meg  
 Emain5 cnmain 0 table {v(mt2,mt1)-1.05\*Vdrm\*v(main4)} (0 0) (1 10)  
 Rmain5 cnmain 0 1meg  
 Emain5r cnmainr 0 table {v(mt1,mt2)-1.05\*Vdrm\*v(main4)} (0 0) (1 10)  
 Rmain5r cnmainr 0 1meg

\* Turn-on/Turn-off control (Quadrant I)

Eonoff contot 0 TABLE  
 + {v(cnmain)+v(congate)+v(cnhold)+v(condvdt)} (0 0) (10 10)

\* Turn-on/Turn-off delays (Quadrant I)

Rton contot dlay1 825

```
Dton dlay1 cntrol Delay
Rtoff contot dlay2 {2.9E-3/Ton}
Dtoff cntrol dlay2 Delay
Cton cntrol 0 {Ton/454}
```

\* Turn-on/Turn-off control (Quadrant III)

```
Eonoffr contotr 0 TABLE
+ {v(cnmainr)+v(congate)+v(cnholdr)+v(condvdt)} (0 0) (10 10)
```

\* Turn-on/Turn-off delays (Quadrant III)

```
Rtonr contotr dlayr1 825
Dtonr dlayr1 cntrolr Delay
Rtoffr contotr dlayr2 {2.9E-3/Ton}
Dtoffr cntrolr dlayr2 Delay
Ctonr cntrolr 0 {Ton/454}
```

\* Controlled switch model

```
.MODEL Vswitch vswitch
+ (Ron = {(Vtm-0.7)/Itm}, Roff = {1.75E-3*Vdrm/Idrm},
+ Von = 5.0, Voff = 1.5)
```

\* Diodes

```
.MODEL Dgk D (Is=1E-16 Cjo=50pf Rs=5)
.MODEL Delay D (Is=1E-12 Cjo=5pf Rs=0.01)
.MODEL Dak D (Is=4E-11 Cjo=5pf)
```

\* Allow the gate to float if required

```
Rfloat gate MT1 1e10
```

.ENDS

\*\$

```
.SUBCKT 2N5444 MT2 gate MT1
```

\* Min and Max parameters

```
X1 MT2 gate MT1 Triac PARAMS:
```

```
+ Vdrm=200v Idrm=10u Ih=70ma dVdt=50e6 Ton=1u
```

```
+ Igt=70ma Vgt=2.0v Vtm=1.65v Itm=56
```

```
* 90-5-18 Morotola DL137, Rev 2, 3/89
```

.ENDS

\*\$

\* Mixed a/d model for Cmos version of 555.

\*

```
.subckt 555d 1 2 3 4 5 6 7 8
```

```
+ params:maxfreq=3e6
```

```
r1 8 5 13k
```

```
r2 5 botm 13k
```

```
r3 botm 0 13k
```

```
m1 7 qb 0 0 nchan l=2u w=1000u
```

```
otop 6 5 cmp dgtlnet=r io_std
```

```
obot botm 2 cmp dgtlnet=s io_std
```

```
ud1 dlyline 8 1 s sd dlymod io_std
```

```
ud2 dlyline 8 1 r rd dlymod io_std
```

```
u1 srff(1) 8 1 strt 4 hi sd rd 3 qb t_srff io_555
```

```

uhigh stim(1,1) 8 1 hi io_stm 0s 1
ustrt stim(1,1) 8 1 strt io_stm 0s 0 1ns 1
.model nchan nmos cgbo=1p cgdo=1p cgso=1p
.model dlymod udly(dlymn={.5/maxfreq}
+ dlyty={.5/maxfreq}
+ dlymx={0.5/maxfreq})
.model cmp doutput(
+ s0name=0 s0vlo=-500 s0vhi=0
+ s1name=1 s1vlo= 0 s1vhi=500)
.model io_555 uio (
+ drvh=96.4 drvl=104
+ atod1="atod_555" atod2="atod_555"
+ atod3="atod_555" atod4="atod_555"
+ dtoa1="dtoa_555" dtoa2="dtoa_555"
+ dtoa3="dtoa_555" dtoa4="dtoa_555")
.model t_srff ugff (tpqcqlhty=120ns)
.ends
.subckt atod_555 a d dpwr dgnd
+ params: capacitance=0
*
o0 a dgnd do555 dgtlnet=d io_std
c1 a 0 {capacitance+0.1pf}
.ends
.subckt dtoa_555 d a dpwr dgnd
+ params: drvl=0 drvh=0 capacitance=0
*
n1 a dgnd dpwr din555 dgtlnet=d io_std
c1 a 0 {capacitance+.1pf}
.ends
.model din555 dinput (
+ s0name="0" s0tsw=0.7ns s0rlo=100 s0rhi=1meg
+ s1name="1" s1tsw=0.7ns s1rlo=1meg s1rhi=300
+ s2name="x" s2tsw=0.7ns s2rlo=200 s2rhi=200
+ s3name="r" s3tsw=0.7ns s3rlo=200 s3rhi=200
+ s4name="f" s4tsw=0.7ns s4rlo=200 s4rhi=200
+ s5name="z" s5tsw=0.7ns s5rlo=200k s5rhi=200k
+ )
.model DO555 doutput (
+ s0name="X" s0vlo=0.8 s0vhi=2.0
+ s1name="0" s1vlo=-1.5 s1vhi=0.8
+ s2name="R" s2vlo=0.8 s2vhi=1.4
+ s3name="R" s3vlo=1.3 s3vhi=2.0
+ s4name="X" s4vlo=0.8 s4vhi=2.0
+ s5name="1" s5vlo=2.0 s5vhi=50.0
+ s6name="F" s6vlo=1.3 s6vhi=2.0
+ s7name="F" s7vlo=0.8 s7vhi=1.4
+ )

```

```

** DIGITAL 555 CONNECTED AS AN ASTABLE
*.LIB EVAL.LIB
*.OPTIONS ITL5=0 ITL1=500
*.PARAM CVAL=20000P
*IVRESET 4 0 PULSE(0 5 1NS .1U .1U 1 2)

```

```
*|C2 OUT 0 10P
*|VCC 8 0 5
*|RA 8 7 4700
*|RB 7 6 2200
*|C1 6 0 {CVAL}
*|X1 0 6 OUT 4 5 6 7 8 555D
*|.TRAN 1N 800U
*|.PROBE
*|.END
*|$
* End of library file
```